

Spring connection with PUSH IN technology (A-Series)
Feed-through terminal blocks

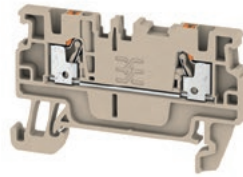

A2C 1.5

1.5 mm²



A3C 1.5

1.5 mm²

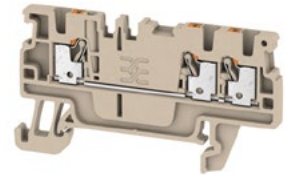

Width/Height/Depth	mm
max. current / max. cond. cross-section	A/mm ²
Max. clamping range	mm ²

3.5 x 55 x 33.5
17.5 / 1.5
0.14...1.5

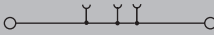

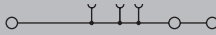

3.5 x 61.5 x 33.5
17.5 / 1.5
0.14...1.5



Technical data

Rated data	
Rated voltage	V
Rated current	A
for wire cross-section	mm ²
Rated impulse withstand voltage / Pollution severity	
Gauge to IEC 60947-1 / UL 94 flammability rating	
Approvals	
Clamped conductors (H05V/H07V)	
Solid / Stranded	mm ²
Flexible / Flexible with ferrule	mm ²
Stripping length / Blade size	mm/-
Note	

IEC 60947-7-1			
IEC	UL	CSA	EN 60079-7
500	300		
17.5	13		
1.5	AWG 26...14		
6 kV / 3			
A1 / V-0			
			
Rated connection			
0.5...1.5 / 0.5...1.5			
0.5...1.5 / 0.5...1			
8 / 0.4 x 2.0 mm			
Note			
Approval in progress			

IEC 60947-7-1			
IEC	UL	CSA	EN 60079-7
500	300		440
17.5	13		
1.5	AWG 26...14		1.5 mm ²
6 kV / 3			
A1 / V-0			
			
TÜV16ATEX7909U			
Rated connection			
0.5...1.5 / 0.5...1.5			
0.5...1.5 / 0.5...1			
8 / 0.4 x 2.0 mm			
Note			
Approval in progress			

Ordering data

Version	
	dark beige
	blue
Note	

Type	Qty.	Order No.
A2C 1.5	100	1552790000
A2C 1.5 BL	100	1552820000

Type	Qty.	Order No.
A3C 1.5	50	1552740000
A3C 1.5 BL	50	1552770000

Accessories

Pluggable cross-connection	
	2-pole
	10-pole
	2-pole
	10-pole
End plate	
	dark beige
	Blue
End bracket	
	dark beige
	dark beige
Test adapter	
	1-pole
	stackable
	3-pole
	5-pole
Test plug	
Screwdriver	
	Standard
Identification systems	

Type	current	Qty.	Order No.
ZQV 1.5N/2	17.5 A	60	1985410000
ZQV 1.5N/10	17.5 A	20	1985580000
AEP 2C 1.5		50	1552600000
AEP 2C 1.5 BL		50	1552610000
AEB 35 SC/1		50	1991920000
AEB 35 SCL/1 VO		50	2661280000
ATPG 1.5-10 L		50	1991890000
ATPG 1.5 MHR		50	1991880000
PS 2.0 MC		20	0310000000
SDS 0.4X2.0X60		1	9037160000
WS 10/3.5 PLUS MC NE WS		960	2003760000
DEK 5/3.5 MM WS		1000	2007100000
WS 8/3.5 MM WS		1000	2007140000
DEK 5/3.5 PLUS MC NE WS		1600	2003750000

Type	current	Qty.	Order No.
ZQV 1.5N/2	17.5 A	60	1985410000
ZQV 1.5N/10	17.5 A	20	1985580000
AEP 3C 1.5		50	1552620000
AEP 3C 1.5 BL		50	1552630000
AEB 35 SC/1		50	1991920000
AEB 35 SCL/1 VO		50	2661280000
ATPG 1.5-10 L		50	1991890000
ATPG 1.5 MHR		50	1991880000
PS 2.0 MC		20	0310000000
SDS 0.4X2.0X60		1	9037160000
WS 10/3.5 PLUS MC NE WS		960	2003760000
DEK 5/3.5 MM WS		1000	2007100000
WS 8/3.5 MM WS		1000	2007140000
DEK 5/3.5 PLUS MC NE WS		1600	2003750000

For detailed information on other accessories and application in the online catalogue

All MultiMark variants (MM) = strip markers

All MultiMark variants (MM) = strip markers

A4C 1.5

1.5 mm²

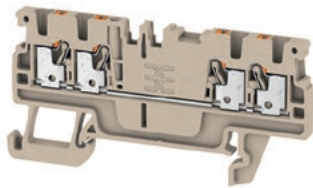

3.5 x 67.5 x 33.5
17.5 / 1.5
0.14...1.5



IEC 60947-7-1

IEC	UL	CSA	EN 60079-7
500	300		
17.5	13		
1.5	AWG 26...14		
6 kV / 3			
A1 / V-0			

CE, VDE, TÜV, UL, IEC, EN

Rated connection

0.5...1.5 / 0.5...1.5

0.5...1.5 / 0.5...1

8 / 0.4 x 2.0 mm

Approval in progress

Type	Qty.	Order No.
A4C 1.5	100	1552690000
A4C 1.5 BL	100	1552700000

Type	current	Qty.	Order No.
ZQV 1.5N/2	17.5 A	60	1985410000
ZQV 1.5N/10	17.5 A	20	1985580000
AEP 4C 1.5		50	1552640000
AEP 4C 1.5 BL		50	1552650000
AEB 35 SC/1		50	1991920000
AEB 35 SCL/1 VO		50	2661280000
ATPG 1.5-10 L		50	1991890000
ATPG 1.5 MI-R		50	1991880000
PS 2.0 MC		20	0310000000
SDS 0.4x2.0x60		1	9037160000
WS 10/3.5 PLUS MC NE WS		960	2003760000
DEK 5/3.5 MM WS		1000	2007100000
WS 8/3.5 MM WS		1000	2007140000
DEK 5/3.5 PLUS MC NE WS		1600	2003750000

All MultiMark variants (MM) = strip markers

A2C 2.5

2.5 mm²

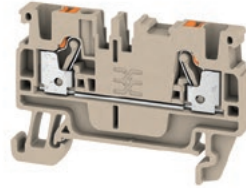

5.1 x 55 x 36.5
24 / 2.5
0.14...2.5



IEC 60947-7-1

IEC	UL	CSA	EN 60079-7
800	600	600	550
24	20	20	
2.5	AWG 28...12	AWG 28...12	2.5 mm ²
8 kV / 3			
A3 / V-0			

CE, VDE, TÜV, UL, IEC, EN

TÜV16ATEX7909U

Rated connection

0.5...2.5 / 0.5...2.5

0.5...2.5 / 0.5...2.5

10 / 0.6 x 3.5 mm

Approval in progress

Type	Qty.	Order No.
A2C 2.5	100	1521850000
A2C 2.5 BL	100	1521880000

Type	current	Qty.	Order No.
ZQV 2.5N/2	24 A	60	1527540000
ZQV 2.5N/10	24 A	20	1527690000
AEP 2C 2.5		50	1514400000
AEP 2C 2.5 BL		50	1514420000
AEB 35 SC/1		50	1991920000
AEB 35 SCL/1 VO		50	2661280000
ATPG 1.5-10 L		50	1991890000
ATPG 2.5 MI-R		50	1991960000
ATPG 2.5/3		25	2041190000
ATPG 2.5/5		25	2041180000
PS 2.0 MC		20	0310000000
SDIL 0.6x3.5x100		1	9042110000
DEK 5/5 PLUS MC NE WS		1000	1854490000
DEK 5/5 MM WS		800	2007110000
WS 8/5 MM WS		800	2007150000
WS 10/5 M PLUS MC NE WS		600	2003770000

All MultiMark variants (MM) = strip markers

A3C 2.5

2.5 mm²

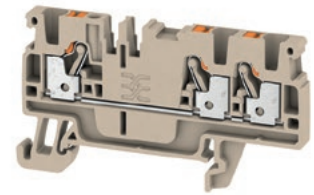

5.1 x 66.5 x 36.5
24 / 2.5
0.14...2.5

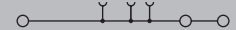

IEC 60947-7-1

IEC	UL	CSA	EN 60079-7
800	600	600	550
24	20	20	
2.5	AWG 28...12	AWG 28...12	2.5 mm ²
8 kV / 3			
A3 / V-0			

CE, VDE, TÜV, UL, IEC, EN

TÜV16ATEX7909U

Rated connection

0.5...2.5 / 0.5...2.5

0.5...2.5 / 0.5...2.5

10 / 0.6 x 3.5 mm

Approval in progress

Type	Qty.	Order No.
A3C 2.5	100	1521740000
A3C 2.5 BL	100	1521780000

Type	current	Qty.	Order No.
ZQV 2.5N/2	24 A	60	1527540000
ZQV 2.5N/10	24 A	20	1527690000
AEP 3C 2.5		50	1521510000
AEP 3C 2.5 BL		50	1521520000
AEB 35 SC/1		50	1991920000
AEB 35 SCL/1 VO		50	2661280000
ATPG 1.5-10 L		50	1991890000
ATPG 2.5 MI-R		50	1991960000
ATPG 2.5/3		25	2041190000
ATPG 2.5/5		25	2041180000
PS 2.0 MC		20	0310000000
SDIL 0.6x3.5x100		1	9042110000
DEK 5/5 PLUS MC NE WS		1000	1854490000
DEK 5/5 MM WS		800	2007110000
WS 8/5 MM WS		800	2007150000
WS 10/5 M PLUS MC NE WS		600	2003770000

All MultiMark variants (MM) = strip markers



Spring connection with PUSH IN technology (A-Series)
Feed-through terminal blocks

Universal range

A



A4C 2.5

2.5 mm²

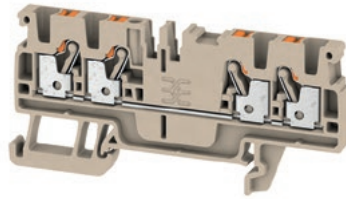

A2C 4

4 mm²

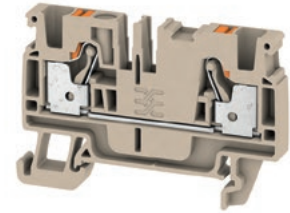

Width/Height/Depth	mm
max. current / max. cond. cross-section	A/mm ²
Max. clamping range	mm ²

5.1 x 77.5 x 36.5	
24 / 2.5	
0.14...2.5	

6.1 x 60 x 39.5	
32 / 4	
0.5...4	

Technical data

Rated data	
Rated voltage	V
Rated current	A
for wire cross-section	mm ²
Rated impulse withstand voltage / Pollution severity	
Gauge to IEC 60947-1 / UL 94 flammability rating	
Approvals	
Clamped conductors (H05V/H07V)	
Solid / Stranded	mm ²
Flexible / Flexible with ferrule	mm ²
Stripping length / Blade size	mm/-
Note	

IEC 60947-7-1			
IEC	UL	CSA	EN 60079-7
800	600	600	550
24	20	20	
2.5	AWG 28...12	AWG 28...12	2.5 mm ²
8 kV / 3			
A3 / V-0			
CE TÜV16ATEX7909U			
Rated connection			
0.5...2.5 / 0.5...2.5			
0.5...2.5 / 0.5...2.5			
10 / 0.6 x 3.5 mm			
Note			
Approval in progress			

IEC 60947-7-1			
IEC	UL	CSA	EN 60079-7
800	600	600	550
32	30	30	
4	AWG 28...10	AWG 26...10	4 mm ²
8 kV / 3			
A4 / V-0			
CE TÜV16ATEX7909U			
Rated connection			
0.5...4 / 0.5...4			
0.5...4 / 0.5...4			
12 / 0.6 x 3.5 mm			
Note			
Approval in progress			

Ordering data

Version	
	dark beige
	blue
Note	

Type	Qty.	Order No.
A4C 2.5	100	1521690000
A4C 2.5 BL	100	1521700000

Type	Qty.	Order No.
A2C 4	100	2051180000
A2C 4 BL	100	2051210000

Accessories

Pluggable cross-connection	
	2-pole
	10-pole
	2-pole
	10-pole
End plate	
	dark beige
	Blue
End bracket	
	dark beige
	dark beige
Test adapter	
	1-pole
	stackable
	3-pole
	5-pole
Test plug	
Screwdriver	
	Standard
Identification systems	

Type	current	Qty.	Order No.
ZQV 2.5N/2	24 A	60	1527540000
ZQV 2.5N/10	24 A	20	1527690000
End plate			
AEP 4C 2.5		50	1521530000
AEP 4C 2.5 BL		50	1521640000
End bracket			
AEB 35 SC/1		50	1991920000
AEB 35 SCL/1 V0		50	2661280000
Test adapter			
ATPG 1.5-10 L		50	1991890000
ATPG 2.5 MHR		50	1991960000
ATPG 2.5/3		25	2041190000
ATPG 2.5/5		25	2041180000
Test plug			
PS 2.0 MC		20	0310000000
Screwdriver			
SDIL 0,6x3,5x100		1	9042110000
Identification systems			
DEK 5/5 PLUS MC NE WS		1000	1854490000
DEK 5/5 MM WS		800	2007110000
WS 8/5 MM WS		800	2007150000
WS 10/5 M PLUS MC NE WS		600	2003770000

Type	current	Qty.	Order No.
ZQV 4N/2	32 A	60	1527930000
ZQV 4N/10	32 A	20	1528090000
End plate			
AEP 2C 4		50	2051680000
AEP 2C 4 BL		50	2051690000
End bracket			
AEB 35 SC/1		50	1991920000
AEB 35 SCL/1 V0		50	2661280000
Test adapter			
ATPG 1.5-10 L		50	1991890000
ATPG 4 MHR		50	1991860000
Test plug			
PS 2.0 MC		20	0310000000
Screwdriver			
SDIL 0,6x3,5x100		1	9042110000
Identification systems			
WS 10/6 M PLUS MC NE WS		600	2003780000
DEK 5/6 MM WS		600	2007120000
WS 8/6 MM WS		600	2007160000
DEK 5/6 PLUS MC NE WS		1000	1011320000

For detailed information on other accessories and application in the online catalogue

All MultiMark variants (MM) = strip markers

All MultiMark variants (MM) = strip markers

A3C 4

4 mm²

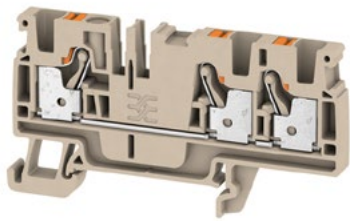

6.1 x 74 x 39.5
32 / 4
0.5...4



IEC 60947-7-1

IEC	UL	CSA	EN 60079-7
800	600	600	550
32	30	30	
4	AWG 28...10	AWG 26...10	4 mm ²
8 kV / 3			
A4 / V-0			

CE TÜV16ATEX7909U

Rated connection

0.5...4 / 0.5...4
0.5...4 / 0.5...4
12 / 0.6 x 3.5 mm

Approval in progress

Type	Qty.	Order No.
A3C 4	50	2051240000
A3C 4 BL	50	2051280000

Type	current	Qty.	Order No.
ZQV 4N/2	32 A	60	1527930000
ZQV 4N/10	32 A	20	1528090000
AEP 3C 4		20	2051720000
AEP 3C 4 BL		20	2051880000
AEB 35 SC/1		50	1991920000
AEB 35 SCL/1 VO		50	2661280000
ATPG 1.5-10 L		50	1991890000
ATPG 4 M-R		50	1991860000
PS 2.0 MC		20	0310000000
SDIL 0,6x3,5x100		1	9042110000
WS 10/6 M PLUS MC NE WS		600	2003780000
DEK 5/6 MM WS		600	2007120000
WS 8/6 MM WS		600	2007160000
DEK 5/6 PLUS MC NE WS		1000	1011320000

All MultiMark variants (MM) = strip markers

A4C 4

4 mm²

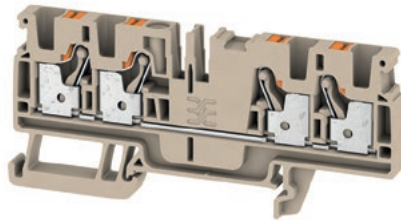

6.1 x 87.5 x 39.5
32 / 4
0.5...4



IEC 60947-7-1

IEC	UL	CSA	EN 60079-7
800	600	600	550
32	30	30	
4	AWG 28...10	AWG 26...10	4 mm ²
8 kV / 3			
A4 / V-0			

CE TÜV16ATEX7909U

Rated connection

0.5...4 / 0.5...4
0.5...4 / 0.5...4
12 / 0.6 x 3.5 mm

Approval in progress

Type	Qty.	Order No.
A4C 4	50	2051500000
A4C 4 BL	50	2051520000

Type	current	Qty.	Order No.
ZQV 4N/2	32 A	60	1527930000
ZQV 4N/10	32 A	20	1528090000
AEP 4C 4		20	2051900000
AEP 4C 4 BL		20	2051910000
AEB 35 SC/1		50	1991920000
AEB 35 SCL/1 VO		50	2661280000
ATPG 1.5-10 L		50	1991890000
ATPG 4 M-R		50	1991860000
PS 2.0 MC		20	0310000000
SDIL 0,6x3,5x100		1	9042110000
WS 10/6 M PLUS MC NE WS		600	2003780000
DEK 5/6 MM WS		600	2007120000
WS 8/6 MM WS		600	2007160000
DEK 5/6 PLUS MC NE WS		1000	1011320000

All MultiMark variants (MM) = strip markers



Spring connection with PUSH IN technology (A-Series)
Feed-through terminal blocks

Universal range

A



A2C 6

6 mm²

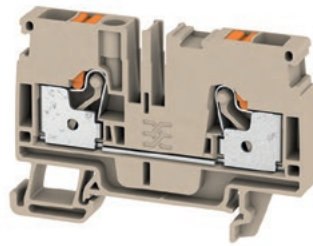

A3C 6

6 mm²

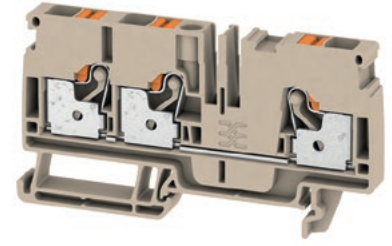

Width/Height/Depth	mm
max. current / max. cond. cross-section	A/mm ²
Max. clamping range	mm ²

8.1 x 66.5 x 45.5
41 / 6
0.5...6

8.1 x 84.5 x 45.5
41 / 6
0.5...6

Technical data

Rated data	
Rated voltage	V
Rated current	A
for wire cross-section	mm ²
Rated impulse withstand voltage / Pollution severity	
Gauge to IEC 60947-1 / UL 94 flammability rating	
Approvals	
Clamped conductors (H05V/H07V)	
Solid / Stranded	mm ²
Flexible / Flexible with ferrule	-
Stripping length / Blade size	mm/-
Note	

IEC 60947-7-1			
IEC	UL	CSA	EN 60079-7
800	600	600	550
41	38	38	
6	AWG 22...8	AWG 22...8	6 mm ²
8 kV / 3			
A5 / V-0			
TÜV16ATEX7909U			
Rated connection			
0.5...6 / 0.5...6			
...6 / 0.5...6			
12 / 1.0 x 5.5 mm			
Approval in progress			

IEC 60947-7-1			
IEC	UL	CSA	EN 60079-7
800	600	600	550
41	38	38	
6	AWG 22...8	AWG 22...8	6 mm ²
8 kV / 3			
A5 / V-0			
TÜV16ATEX7909U			
Rated connection			
0.5...6 / 0.5...6			
...6 / 0.5...6			
12 / 1.0 x 5.5 mm			
Approval in progress			

Ordering data

Version	
	dark beige
	blue
Note	

Type	Qty.	Order No.
A2C 6	50	1992110000
A2C 6 BL	50	1991790000

Type	Qty.	Order No.
A3C 6	50	1991820000
A3C 6 BL	50	1991830000

Accessories

Pluggable cross-connection	2-pole
End plate	dark beige Blue
End bracket	dark beige dark beige
Test adapter	1-pole stackable
Test plug	
Screwdriver	Standard
Identification systems	

Type	current	Qty.	Order No.
ZQV 6N/2	41 A	60	1985740000
AEP 2C 6		50	1991970000
AEP 2C 6 BL		50	1991950000
AEB 35 SC/1		50	1991920000
AEB 35 SCL/1 V0		50	2661280000
ATPG 1.5-10 L		50	1991890000
ATPG 6 M-R		50	1991930000
PS 2.0 MC		20	0310000000
SDIL 1,0x5,5x125		1	9042130000
DEK-A 5/8 MM WS		500	2448860000
WS-A 8/8 MM WS		500	2448930000
DEK 5/8 PLUS MC NE WS		800	1046350000
WS 10/8 PLUS MC NE WS		420	1905950000

Type	current	Qty.	Order No.
ZQV 6N/2	41 A	60	1985740000
AEP 3C 6		50	1991940000
AEP 3C 6 BL		20	1991910000
AEB 35 SC/1		50	1991920000
AEB 35 SCL/1 V0		50	2661280000
ATPG 1.5-10 L		50	1991890000
ATPG 6 M-R		50	1991930000
PS 2.0 MC		20	0310000000
SDIL 1,0x5,5x125		1	9042130000
DEK-A 5/8 MM WS		500	2448860000
WS-A 8/8 MM WS		500	2448930000
DEK 5/8 PLUS MC NE WS		800	1046350000
WS 10/8 PLUS MC NE WS		420	1905950000

For detailed information on other accessories and application in the online catalogue

All MultiMark variants (MM) = strip markers

All MultiMark variants (MM) = strip markers

ALO 6

6 mm²



Width/Height/Depth	mm
max. current / max. cond. cross-section	A/mm ²
Max. clamping range	mm ²

9 x 77 x 45.5
41 / 6
0.5...6



Technical data

Rated data	
Rated voltage	V
Rated current	A
for wire cross-section	mm ²
Rated impulse withstand voltage / Pollution severity	
Gauge to IEC 60947-1 / UL 94 flammability rating	
Approvals	
Clamped conductors (H05V/H07V)	
Solid / Stranded	mm ²
Flexible / Flexible with ferrule	mm ²
Stripping length / Blade size	mm/-

Note

IEC 60947-7-1

IEC	UL	CSA	EN 60079-7
800	600	600	550
41	38	38	
6	AWG 22...8	AWG 22...8	6 mm ²
8 kV / 3			
A5 / V-0			

CE TÜV16ATEX7909U

Rated connection	
0.5...6 / 0.5...6	
0.5...6 / 0.5...6	
12 / 1.0 x 5.5 mm	

Approval in progress

Ordering data

Version	
	dark beige
	blue
Note	

Type	Qty.	Order No.
ALO 6	20	1991780000
ALO 6 BL	20	2065120000

Accessories

Pluggable cross-connection	
	2-pole
	10-pole
	2-pole
	10-pole
End bracket	
	dark beige
	dark beige
Test adapter	
	1-pole
Test plug	
Screwdriver	
	Standard
Identification systems	

Type	current	Qty.	Order No.
ZQV 1.5N/2	17.5 A	60	1985410000
ZQV 1.5N/10	17.5 A	20	1985580000
ZQV 2.5N/2	24 A	60	1527540000
ZQV 2.5N/10	24 A	20	1527690000
AEB 35 SC/1		50	1991920000
AEB 35 SCL/1 V0		50	2661280000
ATPG 1.5-10 L		50	1991890000
PS 2.0 MC		20	0310000000
SDIL 1,0x5,5x125		1	9042130000
WS 7.8/9.2 PLUS MC NE GR		360	1208970000

For detailed information on other accessories and application in the online catalogue

All MultiMark variants (MM) = strip markers



A2C 16

16 mm²

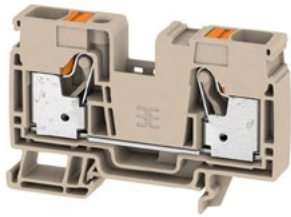

12 x 80.5 x 51.5
/ 16
0.75...16

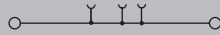

IEC 60947-7-1

IEC	UL	CSA	EN 60079-7
1000			
76			
16			
8 kV / 3			
A6 / V-0			

EH

Rated connection

0.75...10 / 0.75...16
0.75...16 / 1.5...16
18 / 1.0 x 5.5 mm

Approval in progress

Type	Qty.	Order No.
A2C 16	20	2494000000
A2C 16 BL	20	2494100000

Type	current	Qty.	Order No.
ZQV 16N/2		25	2497290000
AEB 35 SC/1		50	1991920000
AEB 35 SCL/1 VO		50	2661280000
PS 2.0 MC		20	0310000000
SDIL 1,0x5,5x125		1	9042130000
WS 7.8/9.2 PLUS MC NE GR		360	1208970000
AEP 3C 10/16		20	2490530000
AEP 3C 10/16 BL		20	2490540000

All MultiMark variants (MM) = strip markers

A3C 16

16 mm²



12 x 102 x 51.5
/ 16
0.75...16

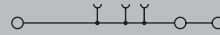

IEC 60947-7-1

IEC	UL	CSA	EN 60079-7
1000			
76			
16			
8 kV / 3			
A6 / V-0			

EH

Rated connection

0.75...10 / 0.75...16
0.75...16 / 1.5...16
18 / 1.0 x 5.5 mm

Approval in progress

Type	Qty.	Order No.
A3C 16	20	2494090000
A3C 16 BL	20	2494080000

Type	current	Qty.	Order No.
ZQV 16N/2		25	2497290000
AEB 35 SC/1		50	1991920000
AEB 35 SCL/1 VO		50	2661280000
PS 2.0 MC		20	0310000000
SDIL 1,0x5,5x125		1	9042130000
WS 7.8/9.2 PLUS MC NE GR		360	1208970000
AEP 3C 10/16		20	2490530000
AEP 3C 10/16 BL		20	2490540000

All MultiMark variants (MM) = strip markers

ALO 16

16 mm²

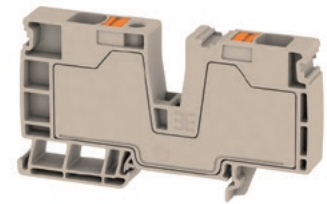

12 x 95.5 x 51.5
/ 16
0.75...16

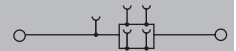

IEC 60947-7-1

IEC	UL	CSA	EN 60079-7
800			
76			
16			
8 kV / 3			
A6 / V-0			

Rated connection

0.75...10 / 0.75...16
0.75...16 / 1.5...16
18 / 1.0 x 5.5 mm

Approval in progress

Type	Qty.	Order No.
ALO 16	20	2502280000
ALO 16 BL	20	2502320000

Type	current	Qty.	Order No.
ZQV 1.5N/2	17.5 A	60	1985410000
ZQV 1.5N/10	17.5 A	20	1985580000
ZQV 2.5N/2	24 A	60	1527540000
ZQV 2.5N/10	24 A	20	1527690000
ZQV 4N/2	32 A	60	1527930000
ZQV 4N/10	32 A	20	1528090000
ZQV 6N/2	41 A	60	1985740000
AEB 35 SC/1		50	1991920000
AEB 35 SCL/1 VO		50	2661280000
ATPG 1.5-10 L		50	1991890000
PS 2.0 MC		20	0310000000
SDIL 1,0x5,5x125		1	9042130000
WS 7.8/9.2 PLUS MC NE GR		360	1208970000

All MultiMark variants (MM) = strip markers



Spring connection with PUSH IN technology (A-Series)
Feed-through terminal blocks

Universal range

A



A2C 35

35 mm²



A2C 35 DM

35 mm²



Width/Height/Depth	mm
max. current / max. cond. cross-section	-/mm ²
Max. clamping range	mm ²

16 x 71.5 x 101.5	
125 / 35	
2.5...35	

16 x 71.5 x 135	
125 / 135	
2.5...35	

Technical data

Rated data	
Rated voltage	V
Rated current	A
for wire cross-section	mm ²
Rated impulse withstand voltage / Pollution severity	
Gauge to IEC 60947-1 / UL 94 flammability rating	
Approvals	
Clamped conductors (H05V/H07V)	
Solid / Stranded	mm ²
Flexible / Flexible with ferrule	mm ²
Stripping length / Blade size	mm/-
Note	

IEC 60947-7-1				
IEC	UL	CSA	EN 60079-7	
1000				
125				
35				
		8 kV / 3		
		/V-0		
Rated connection				
2.5...35 / 2.5...35				
10...35 / 2.5...35				
25 /				
Note				
Approval in progress				

IEC 60947-7-1				
IEC	UL	CSA	EN 60079-7	
1000				
125				
35				
		8 kV / 3		
		/V-0		
Rated connection				
2.5...35 / 2.5...3.5				
10...35 / 2.5...35				
25 /				
Note				
Approval in progress				

Ordering data

Version	
	dark beige
	blue
Note	

Type	Qty.	Order No.
A2C 35	10	2551510000
A2C 35 BL	10	2552090000

Type	Qty.	Order No.
A2C 35 DM	10	2551550000
A2C 35 BL DM	10	2552150000

Accessories

Pluggable cross-connection		
	2-pole	
	10-pole	
End plate		
	dark beige	
	Blue	
End bracket		
	dark beige	
	dark beige	
Test adapter		
	1-pole	
	stackable	
Test plug		
Screwdriver		
	Standard	
Identification systems		
DEK-A 5/8 MM WS	500	2448860000
WS-A 8/8 MM WS	500	2448930000
DEK 5/8 PLUS MC NE WS	800	1046350000
WS 10/8 PLUS MC NE WS	420	1905950000

Type	current	Qty.	Order No.
ZQV 35N/2	125 A	10	2634950000
AEB 35 SC/1		50	1991920000
AEB 35 SCL/1 VO		50	2661280000
ATPG 1.5-10 L		50	1991890000
PS 2.0 MC		20	0310000000
DEK-A 5/8 MM WS		500	2448860000
WS-A 8/8 MM WS		500	2448930000
DEK 5/8 PLUS MC NE WS		800	1046350000
WS 10/8 PLUS MC NE WS		420	1905950000

Type	current	Qty.	Order No.
ZQV 35N/2	125 A	10	2634950000
AEB 35 SC/1		50	1991920000
AEB 35 SCL/1 VO		50	2661280000
ATPG 1.5-10 L		50	1991890000
PS 2.0 MC		20	0310000000
DEK-A 5/8 MM WS		500	2448860000
WS-A 8/8 MM WS		500	2448930000
DEK 5/8 PLUS MC NE WS		800	1046350000
WS 10/8 PLUS MC NE WS		420	1905950000

For detailed information on other accessories and application in the online catalogue

All MultiMark variants (MM) = strip markers

All MultiMark variants (MM) = strip markers



A2T 1.5

1.5 mm²

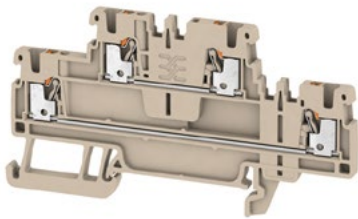

3.5 x 84 x 45
/ 1.5
0.14...1.5



IEC 60947-7-1

IEC	UL	CSA	EN 60079-7
500			
17.5			
1.5			
6 kV / 3			
A1 / V-0			

EM

Rated connection

0.5...1.5 / 0.5...1.5

0.5...1.5 / 0.5...1

8 / 0.4 x 2.0 mm

Approval in progress

Type	Qty.	Order No.
A2T 1.5	50	2469370000
A2T 1.5 BL	50	2471430000

Type	current	Qty.	Order No.
ZQV 1.5N/2	17.5 A	60	1985410000
ZQV 1.5N/10	17.5 A	20	1985580000
AEP 2T 1.5		20	2469420000
AEP 2T 1.5 BL		20	2471470000
AEB 35 SC/1		50	1991920000
AEB 35 SCL/1 VO		50	2661280000
ATPG 1.5-10 L		50	1991890000
ATPG 1.5 MI-R		50	1991880000
PS 2.0 MC		20	0310000000
SDS 0.4X2.0X60		1	9037160000
WS 10/3.5 PLUS MC NE WS		960	2003760000
DEK 5/3.5 MM WS		1000	2007100000
WS 8/3.5 MM WS		1000	2007140000
DEK 5/3.5 PLUS MC NE WS		1600	2003750000
SNAPMARK I		50	1805880000

All MultiMark variants (MM) = strip markers

A2T 1.5 VL

1.5 mm²

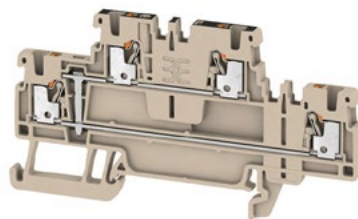

3.5 x 84 x 45
/ 1.5
0.14...1.5

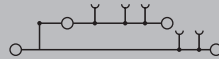

IEC 60947-7-1

IEC	UL	CSA	EN 60079-7
500			
17.5			
1.5			
6 kV / 3			
A1 / V-0			

EM

Rated connection

0.5...1.5 / 0.5...1.5

0.5...1.5 / 0.5...1

8 / 0.4 x 2.0 mm

Approval in progress

Type	Qty.	Order No.
A2T 1.5 VL	50	2469400000
A2T 1.5 VL BL	50	2471450000

Type	current	Qty.	Order No.
ZQV 1.5N/2	17.5 A	60	1985410000
ZQV 1.5N/10	17.5 A	20	1985580000
AEP 2T 1.5		20	2469420000
AEP 2T 1.5 BL		20	2471470000
AEB 35 SC/1		50	1991920000
AEB 35 SCL/1 VO		50	2661280000
ATPG 1.5-10 L		50	1991890000
ATPG 1.5 MI-R		50	1991880000
PS 2.0 MC		20	0310000000
SDS 0.4X2.0X60		1	9037160000
WS 10/3.5 PLUS MC NE WS		960	2003760000
DEK 5/3.5 MM WS		1000	2007100000
WS 8/3.5 MM WS		1000	2007140000
DEK 5/3.5 PLUS MC NE WS		1600	2003750000
SNAPMARK I		50	1805880000

All MultiMark variants (MM) = strip markers

A2T 1.5 FT-PE

1.5 mm²

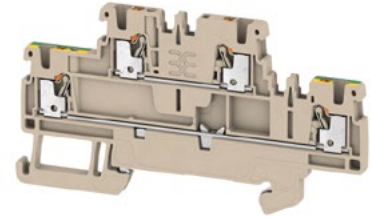

3.5 x 84 x 45
/ 1.5
0.14...1.5



IEC 60947-7-1, IEC 60947-7-2

IEC	UL	CSA	EN 60079-7
500			
17.5			
1.5			
6 kV / 3			
A1 / V-0			

EM

Rated connection

0.5...1.5 / 0.5...1.5

0.5...1.5 / 0.5...1

8 / 0.4 x 2.0 mm

Approval in progress

Type	Qty.	Order No.
A2T 1.5 FT-PE	50	2469390000

Type	current	Qty.	Order No.
ZQV 1.5N/2	17.5 A	60	1985410000
ZQV 1.5N/10	17.5 A	20	1985580000
AEP 2T 1.5		20	2469420000
AEP 2T 1.5 BL		20	2471470000
AEB 35 SC/1		50	1991920000
AEB 35 SCL/1 VO		50	2661280000
ATPG 1.5-10 L		50	1991890000
ATPG 1.5 MI-R		50	1991880000
PS 2.0 MC		20	0310000000
SDS 0.4X2.0X60		1	9037160000
WS 10/3.5 PLUS MC NE WS		960	2003760000
DEK 5/3.5 MM WS		1000	2007100000
WS 8/3.5 MM WS		1000	2007140000
DEK 5/3.5 PLUS MC NE WS		1600	2003750000
SNAPMARK I		50	1805880000

All MultiMark variants (MM) = strip markers

Spring connection with PUSH IN technology (A-Series)
Feed-through terminal blocks

Universal range

A



A2T 2.5

2.5 mm²

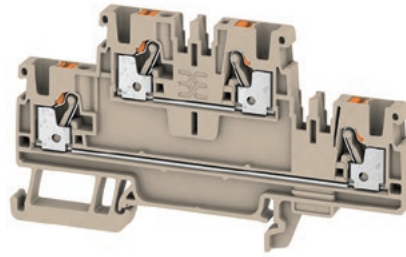

5.1 x 90 x 50.5	
24 / 2.5	
0.14...2.5	

A2T 2.5 SNAPMARK

2.5 mm²

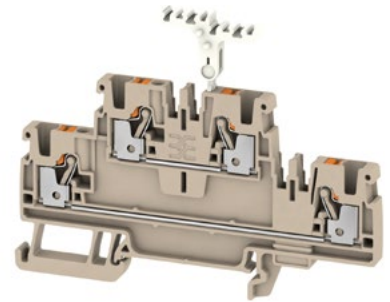

5.1 x 90 x 69	
24 / 2.5	
0.14...2.5	

Width/Height/Depth	mm
max. current / max. cond. cross-section	A/mm ²
Max. clamping range	mm ²

Technical data

Rated data	
Rated voltage	V
Rated current	A
for wire cross-section	mm ²
Rated impulse withstand voltage / Pollution severity	
Gauge to IEC 60947-1 / UL 94 flammability rating	
Approvals	
Clamped conductors (H05V/H07V)	
Solid / Stranded	mm ²
Flexible / Flexible with ferrule	mm ²
Stripping length / Blade size	mm/-
Note	

IEC 60947-7-1

IEC	UL	CSA	EN 60079-7
800	600	600	550
24	20	20	21
2.5	AWG 28...12	AWG 28...12	2.5 mm ²
8 kV / 3			
A3 / V-0			
TÜV16ATEX7909U			
Rated connection			
0.5...2.5 / 0.5...2.5			
0.5...2.5 / 0.5...2.5			
10 / 0.6 x 3.5 mm			
Note			
Approval in progress			

IEC 60947-7-1

IEC	UL	CSA	EN 60079-7
800	600	600	550
24	20	20	21
2.5	AWG 28...12	AWG 28...12	2.5 mm ²
8 kV / 3			
A3 / V-0			
TÜV16ATEX7909U			
Rated connection			
0.5...2.5 / 0.5...2.5			
0.5...2.5 / 0.5...2.5			
10 / 0.6 x 3.5 mm			
Note			
Approval in progress			

Ordering data

Version	
	dark beige
	blue
Note	

Type	Qty.	Order No.
A2T 2.5	50	1547610000
A2T 2.5 BL	50	1547620000

Type	Qty.	Order No.
A2T 2.5 SNAPMARK	50	2581250000
A2T 2.5 SNAPMARK BL	50	2581280000

Accessories

Pluggable cross-connection	
	2-pole
	10-pole
End plate	
	dark beige
	blue
End bracket	
	dark beige
	dark beige
Test adapter	
	1-pole
	stackable
	3-pole
	5-pole
Test plug	
Screwdriver	
	Standard
Identification systems	

Type	current	Qty.	Order No.
ZQV 2.5N/2	24 A	60	1527540000
ZQV 2.5N/10	24 A	20	1527690000
AEP 2T 2.5	20	1547690000	
AEP 2T 2.5 BL	20	1547700000	
AEB 35 SC/1	50	1991920000	
AEB 35 SCL/1 V0	50	2661280000	
ATPG 1.5-10 L	50	1991890000	
ATPG 2.5 MHR	50	1991960000	
ATPG 2.5/3	25	2041190000	
ATPG 2.5/5	25	2041180000	
PS 2.0 MC	20	0310000000	
SDIL 0,6x3,5x100	1	9042110000	
DEK 5/5 PLUS MC NE WS	1000	1854490000	
DEK 5/5 MM WS	800	2007110000	
WS 8/5 MM WS	800	2007150000	
WS 10/5 M PLUS MC NE WS	600	2003770000	
SNAPMARK I	50	1805880000	

Type	current	Qty.	Order No.
ZQV 2.5N/2	24 A	60	1527540000
ZQV 2.5N/10	24 A	20	1527690000
AEP 2T 2.5	20	1547690000	
AEP 2T 2.5 BL	20	1547700000	
AEB 35 SC/1	50	1991920000	
AEB 35 SCL/1 V0	50	2661280000	
ATPG 1.5-10 L	50	1991890000	
ATPG 2.5 MHR	50	1991960000	
ATPG 2.5/3	25	2041190000	
ATPG 2.5/5	25	2041180000	
PS 2.0 MC	20	0310000000	
SDIL 0,6x3,5x100	1	9042110000	
DEK 5/5 PLUS MC NE WS	1000	1854490000	
DEK 5/5 MM WS	800	2007110000	
WS 8/5 MM WS	800	2007150000	
WS 10/5 M PLUS MC NE WS	600	2003770000	

For detailed information on other accessories and application in the online catalogue

All MultiMark variants (MM) = strip markers

All MultiMark variants (MM) = strip markers

A2T 2.5 VL

2.5 mm²

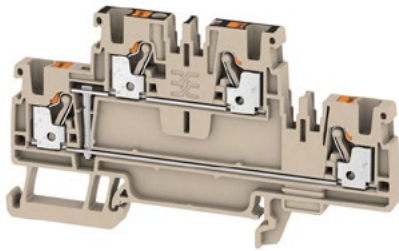

5.1 x 90 x 50.5
24 / 2.5
0.14...2.5

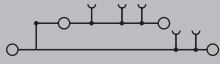

IEC 60947-7-1

IEC	UL	CSA	EN 60079-7
800	600	600	550
24	20	20	21
2.5	AWG 28...12	AWG 28...12	2.5 mm ²
8 kV / 3			
A3 / V-0			

CE TÜV16ATEX7909U

Rated connection

0.5...2.5 / 0.5...2.5

0.5...2.5 / 0.5...2.5

10 / 0.6 x 3.5 mm

Approval in progress

Type	Qty.	Order No.
A2T 2.5 VL	50	1547650000
A2T 2.5 VL BL	50	1547660000

Type	current	Qty.	Order No.
ZQV 2.5N/2	24 A	60	1527540000
ZQV 2.5N/10	24 A	20	1527690000
AEP 2T 2.5		20	1547690000
AEP 2T 2.5 BL		20	1547700000
AEB 35 SC/1		50	1991920000
AEB 35 SCL/1 VO		50	2661280000
ATPG 1.5-10 L		50	1991890000
ATPG 2.5 MI-R		50	1991960000
ATPG 2.5/3		25	2041190000
ATPG 2.5/5		25	2041180000
PS 2.0 MC		20	0310000000
SDIL 0,6x3,5x100		1	9042110000
DEK 5/5 PLUS MC NE WS		1000	1854490000
DEK 5/5 MM WS		800	2007110000
WS 8/5 MM WS		800	2007150000
WS 10/5 M PLUS MC NE WS		600	2003770000
SNAPMARK I		50	1805880000

All MultiMark variants (MM) = strip markers

A2T 2.5 FT-PE

2.5 mm²

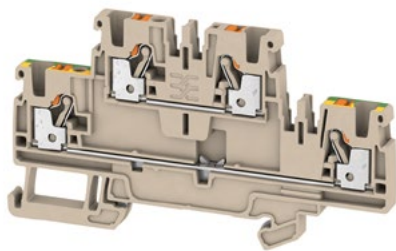

5.1 x 90 x 50.5
24 / 2.5
0.14...2.5



IEC 60947-7-1, IEC 60947-7-2

IEC	UL	CSA	EN 60079-7
800	600	600	550
24	20	20	21
2.5	AWG 28...12	AWG 28...12	2.5 mm ²
8 kV / 3			
A3 / V-0			

CE TÜV16ATEX7909U

Rated connection

0.5...2.5 / 0.5...2.5

0.5...2.5 / 0.5...2.5

10 / 0.6 x 3.5 mm

Approval in progress

Type	Qty.	Order No.
A2T 2.5 FT-PE	50	1547640000

Type	current	Qty.	Order No.
ZQV 2.5N/2	24 A	60	1527540000
ZQV 2.5N/10	24 A	20	1527690000
AEP 2T 2.5		20	1547690000
AEP 2T 2.5 BL		20	1547700000
AEB 35 SC/1		50	1991920000
AEB 35 SCL/1 VO		50	2661280000
ATPG 1.5-10 L		50	1991890000
ATPG 2.5 MI-R		50	1991960000
ATPG 2.5/3		25	2041190000
ATPG 2.5/5		25	2041180000
PS 2.0 MC		20	0310000000
SDIL 0,6x3,5x100		1	9042110000
DEK 5/5 PLUS MC NE WS		1000	1854490000
DEK 5/5 MM WS		800	2007110000
WS 8/5 MM WS		800	2007150000
WS 10/5 M PLUS MC NE WS		600	2003770000
SNAPMARK I		50	1805880000

All MultiMark variants (MM) = strip markers

A2T 2.5 3C

2.5 mm²



5.1 x 114.5 x 64
24 / 2.5
0.14...2.5

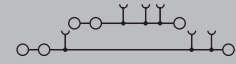

IEC 60947-7-1

IEC	UL	CSA	EN 60079-7
800			550
24			21
2.5			2.5 mm ²
8 kV / 3			
A3 / V-0			

TÜV16ATEX7909U

Rated connection

0.5...2.5 / 0.5...2.5

0.5...2.5 / 0.5...2.5

10 / 0.6 x 3.5 mm

Approval in progress

Type	Qty.	Order No.
A2T 2.5 3C	50	2531290000
A2T 2.5 3C BL	50	2531510000

Type	current	Qty.	Order No.
ZQV 2.5N/2	24 A	60	1527540000
ZQV 2.5N/10	24 A	20	1527690000
AEP 2T 2.5 3C		20	2532690000
AEP 2T 2.5 3C BL		20	2532700000
AEB 35 SC/1		50	1991920000
AEB 35 SCL/1 VO		50	2661280000
ATPG 1.5-10 L		50	1991890000
ATPG 2.5 MI-R		50	1991960000
ATPG 2.5/3		25	2041190000
ATPG 2.5/5		25	2041180000
PS 2.0 MC		20	0310000000
SDIL 0,6x3,5x100		1	9042110000
DEK 5/5 PLUS MC NE WS		1000	1854490000
DEK 5/5 MM WS		800	2007110000
WS 8/5 MM WS		800	2007150000
WS 10/5 M PLUS MC NE WS		600	2003770000
SNAPMARK I		50	1805880000

All MultiMark variants (MM) = strip markers



Spring connection with PUSH IN technology (A-Series)
Feed-through terminal blocks

Universal range

A



A2T 2.5 3C VL

2.5 mm²



A2T 2.5 3C FT-PE

2.5 mm²



Width/Height/Depth	mm
max. current / max. cond. cross-section	A/mm ²
Max. clamping range	mm ²

5.1 x 114.5 x 64	
24 / 2.5	
0.14...2.5	

5.1 x 114.5 x 64	
24 / 2.5	
0.14...2.5	

Technical data

Rated data	
Rated voltage	V
Rated current	A
for wire cross-section	mm ²
Rated impulse withstand voltage / Pollution severity	
Gauge to IEC 60947-1 / UL 94 flammability rating	
Approvals	
Clamped conductors (H05V/H07V)	
Solid / Stranded	mm ²
Flexible / Flexible with ferrule	mm ²
Stripping length / Blade size	mm/-
Note	

IEC 60947-7-1			
IEC	UL	CSA	EN 60079-7
800			550
24			21
2.5			2.5 mm ²
8 kV / 3			
A3 / V-0			
TÜV16ATEX7909U			
Rated connection			
0.5...2.5 / 0.5...2.5			
0.5...2.5 / 0.5...2.5			
10 / 0.6 x 3.5 mm			
Note			
Approval in progress			

IEC 60947-7-1			
IEC	UL	CSA	EN 60079-7
800			550
24			21
2.5			2.5 mm ²
8 kV / 3			
A3 / V-0			
TÜV16ATEX7909U			
Rated connection			
0.5...2.5 / 0.5...2.5			
0.5...2.5 / 0.5...2.5			
10 / 0.6 x 3.5 mm			
Note			
Approval in progress			

Ordering data

Version	
	dark beige
	blue
Note	

Type	Qty.	Order No.
A2T 2.5 3C VL	50	2531310000
A2T 2.5 3C VL BL	50	2531530000

Type	Qty.	Order No.
A2T 2.5 3C FT-PE	50	2531300000

Accessories

Pluggable cross-connection	
	2-pole
	10-pole
End plate	
	dark beige
	blue
End bracket	
	dark beige
	dark beige
Test adapter	
	1-pole
	stackable
	3-pole
	5-pole
Test plug	
Screwdriver	
	Standard
Identification systems	

Type	current	Qty.	Order No.
ZQV 2.5N/2	24 A	60	1527540000
ZQV 2.5N/10	24 A	20	1527690000
AEP 2T 2.5 3C		20	2532690000
AEP 2T 2.5 3C BL		20	2532700000
AEB 35 SC/1		50	1991920000
AEB 35 SCL/1 VO		50	2661280000
ATPG 1.5-10 L		50	1991890000
ATPG 2.5 MHR		50	1991960000
ATPG 2.5/3		25	2041190000
ATPG 2.5/5		25	2041180000
PS 2.0 MC		20	0310000000
SDIL 0,6x3,5x100		1	9042110000
DEK 5/5 PLUS MC NE WS		1000	1854490000
DEK 5/5 MM WS		800	2007110000
WS 8/5 MM WS		800	2007150000
WS 10/5 M PLUS MC NE WS		600	2003770000
SNAPMARK I		50	1805880000

Type	current	Qty.	Order No.
ZQV 2.5N/2	24 A	60	1527540000
ZQV 2.5N/10	24 A	20	1527690000
AEP 2T 2.5 3C		20	2532690000
AEP 2T 2.5 3C BL		20	2532700000
AEB 35 SC/1		50	1991920000
AEB 35 SCL/1 VO		50	2661280000
ATPG 1.5-10 L		50	1991890000
ATPG 2.5 MHR		50	1991960000
ATPG 2.5/3		25	2041190000
ATPG 2.5/5		25	2041180000
PS 2.0 MC		20	0310000000
SDIL 0,6x3,5x100		1	9042110000
DEK 5/5 PLUS MC NE WS		1000	1854490000
DEK 5/5 MM WS		800	2007110000
WS 8/5 MM WS		800	2007150000
WS 10/5 M PLUS MC NE WS		600	2003770000
SNAPMARK I		50	1805880000

For detailed information on other accessories and application in the online catalogue

All MultiMark variants (MM) = strip markers

All MultiMark variants (MM) = strip markers

A2T 2.5 3C N-PE

2,5 mm²



5.1 x 114.5 x 64
24 / 2,5
0,14...2,5

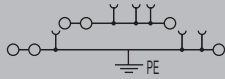

IEC 60947-7-1

IEC	UL	CSA	EN 60079-7
800			550
24			21
2.5			2.5 mm ²
8 kV / 3			
A3 / V-0			

Ⓢ TÜV16ATEX7909U

Rated connection

0.5...2.5 / 0.5...2.5
0.5...2.5 / 0.5...2.5
10 / 0.6 x 3.5 mm

Approval in progress

Type	Qty.	Order No.
A2T 2.5 3C N-PE	50	2623550000

Type	current	Qty.	Order No.
ZQV 2.5N/2	24 A	60	1527540000
ZQV 2.5N/10	24 A	20	1527690000
AEP 2T 2.5 3C		20	2532690000
AEP 2T 2.5 3C BL		20	2532700000
AEB 35 SC/1		50	1991920000
AEB 35 SCL/1 V0		50	2661280000
ATPG 1.5-10 L		50	1991890000
ATPG 2.5 MI-R		50	1991960000
ATPG 2.5/3		25	2041190000
ATPG 2.5/5		25	2041180000
PS 2.0 MC		20	0310000000
SDIL 0,6x3,5x100		1	9042110000
DEK 5/5 PLUS MC NE WS		1000	1854490000
DEK 5/5 MM WS		800	2007110000
WS 8/5 MM WS		800	2007150000
WS 10/5 M PLUS MC NE WS		600	2003770000
SNAPMARK I		50	1805880000

All MultiMark variants (MM) = strip markers

A2T 4

4 mm²

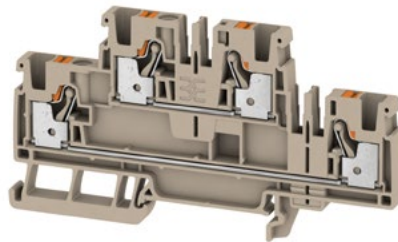

6.1 x 100 x 53.5
32 / 4
0,14...4

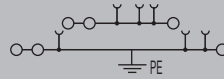

IEC 60947-7-1

IEC	UL	CSA	EN 60079-7
800	600		
32	30		
4	AWG 26...10		
8 kV / 3			
A4 / V-0			

Ⓢ

Rated connection

0.5...4 / 0.5...4
0.5...4 / 0.5...4
12 / 0.6 x 3.5 mm

Approval in progress

Type	Qty.	Order No.
A2T 4	50	2539970000
A2T 4 BL	50	2540040000

Type	current	Qty.	Order No.
ZQV 4N/2	32 A	60	1527930000
ZQV 4N/10	32 A	20	1528090000
AEP 2T 4		20	2540000000
AEP 2T 4 BL		20	2540010000
AEB 35 SC/1		50	1991920000
AEB 35 SCL/1 V0		50	2661280000
ATPG 1.5-10 L		50	1991890000
ATPG 4 MHR		50	1991860000
PS 2.0 MC		20	0310000000
SDIL 0,6x3,5x100		1	9042110000
WS 10/6 PLUS MC NE WS		600	2003780000
DEK 5/6 MM WS		600	2007120000
WS 8/6 MM WS		600	2007160000
DE 5/6 PLUS MC NE WS		1000	1011320000
SNAPMARK I		50	1805880000

All MultiMark variants (MM) = strip markers

A2T 4 VL

4 mm²

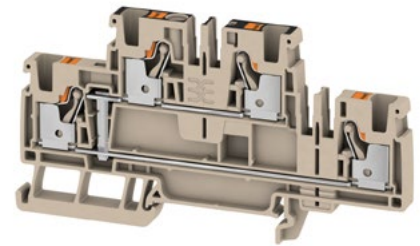

6.1 x 100 x 53.5
32 / 4
0,14...4

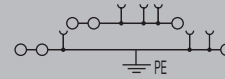

IEC 60947-7-1

IEC	UL	CSA	EN 60079-7
800	600		
32	30		
4	AWG 26...10		
8 kV / 3			
A4 / V-0			

Ⓢ

Rated connection

0.5...4 / 0.5...4
0.5...4 / 0.5...4
12 / 0.6 x 3.5 mm

Approval in progress

Type	Qty.	Order No.
A2T 4 VL	50	2540020000
A2T 4 VL BL	50	2540030000

Type	current	Qty.	Order No.
ZQV 4N/2	32 A	60	1527930000
ZQV 4N/10	32 A	20	1528090000
AEP 2T 4		20	2540000000
AEP 2T 4 BL		20	2540010000
AEB 35 SC/1		50	1991920000
AEB 35 SCL/1 V0		50	2661280000
ATPG 1.5-10 L		50	1991890000
ATPG 4 MHR		50	1991860000
PS 2.0 MC		20	0310000000
SDIL 0,6x3,5x100		1	9042110000
WS 10/6 PLUS MC NE WS		600	2003780000
DEK 5/6 MM WS		600	2007120000
WS 8/6 MM WS		600	2007160000
DE 5/6 PLUS MC NE WS		1000	1011320000
SNAPMARK I		50	1805880000

All MultiMark variants (MM) = strip markers



Spring connection with PUSH IN technology (A-Series)

Feed-through terminal blocks

Universal range

A



A2T 4 FT-PE

4 mm²

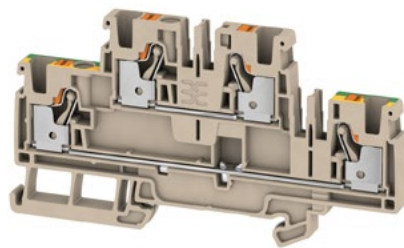

Width/Height/Depth	mm
max. current / max. cond. cross-section	A/mm ²
Max. clamping range	mm ²

6.1 x 100 x 53.5	
32 / 4	
0.14...4	

Technical data

Rated data	
Rated voltage	V
Rated current	A
for wire cross-section	mm ²
Rated impulse withstand voltage / Pollution severity	
Gauge to IEC 60947-1 / UL 94 flammability rating	
Approvals	
Clamped conductors (H05V/H07V)	
Solid / Stranded	mm ²
Flexible / Flexible with ferrule	mm ²
Stripping length / Blade size	mm/-
Note	

Ordering data

Version	
	dark beige
	blue
Note	

Accessories

Pluggable cross-connection	
	2-pole
	10-pole
End plate	
	dark beige
	blue
End bracket	
	dark beige
	dark beige
Test adapter	
	1-pole
	stackable
	3-pole
	5-pole
Test plug	
Screwdriver	
	Standard
Identification systems	

For detailed information on other accessories and application in the online catalogue

A3T 2.5

2.5 mm²

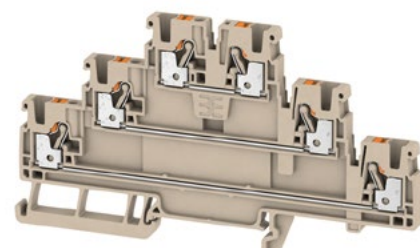

5.1 x 116 x 64.5	
22 / 2.5	
0.14...2.5	

DIN EN 60947-7-1

IEC	UL	CSA	EN 60079-7
800	600		
22	30		
2.5	AWG 26...10		
8 kV / 3			
A4 / V-0			
CE			
Rated connection			
0.5...4 / 0.5...4			
0.5...4 / 0.5...4			
12 / 0.6 x 3.5 mm			
Approval in progress			

Type	Qty.	Order No.
A3T 2.5	50	2428510000
A3T 2.5 BL	50	2428520000

Type	current	Qty.	Order No.
ZQV 4N/2	32 A	60	1527930000
ZQV 4N/10	32 A	20	1528090000
AEP 2T 4	20	2540000000	
AEP 2T 4 BL	20	2540010000	
AEB 35 SC/1	50	1991920000	
AEB 35 SCL/1 VO	50	2661280000	
ATPG 1.5-10 L	50	1991890000	
ATPG 4 MHR	50	1991860000	
		25	
		25	
PS 2.0 MC	20	0310000000	
SDIL 0,6x3,5x100	1	9042110000	
WS 10/6 PLUS MC NE WS	600	2003780000	
DEK 5/6 MM WS	600	2007120000	
WS 8/6 MM WS	600	2007160000	
DE 5/6 PLUS MC NE WS	1000	1011320000	
SNAPMARK I	50	1805880000	
ZQV 2.5N/2	24 A	60	1527540000
ZQV 2.5N/10	24 A	20	1527690000
AEP 3T 2.5	20	2428560000	
AEP 3T 2.5 BL	20	2428860000	
AEB 35 SC/1	50	1991920000	
AEB 35 SCL/1 VO	50	2661280000	
ATPG 1.5-10 L	50	1991890000	
ATPG 2.5 MHR	50	1991960000	
ATPG 2.5/3	25	2041190000	
ATPG 2.5/5	25	2041180000	
PS 2.0 MC	20	0310000000	
SDIL 0,6x3,5x100	1	9042110000	
DEK 5/5 PLUS MC NE WS	1000	1854490000	
DEK 5/5 MM WS	800	2007110000	
WS 8/5 MM WS	800	2007150000	
WS 10/5 M PLUS MC NE WS	600	2003770000	
SNAPMARK I	50	1805880000	

All MultiMark variants (MM) = strip markers

All MultiMark variants (MM) = strip markers

A3T 2.5 VL

2.5 mm²

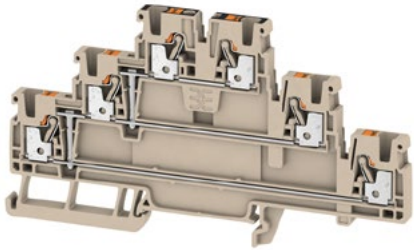

5.1 x 116 x 64.5
24 / 2.5
0.14...2.5

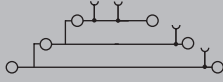

DIN EN 60947-7-1

IEC	UL	CSA	EN 60079-7
800	300		
24	20		
2.5	AWG 28...12		
			8 kV / 3
			A3 / V-0



Rated connection

0.5...2.5 / 0.5...2.5
0.5...2.5 / 0.5...2.5
10 / 0.6 x 3.5 mm

Approval in progress

Type	Qty.	Order No.
A3T 2.5 VL	25	2428540000
A3T 2.5 VL BL	25	2428850000

Type	current	Qty.	Order No.
ZQV 2.5N/2	24 A	60	1527540000
ZQV 2.5N/10	24 A	20	1527690000
AEP 3T 2.5		20	2428560000
AEP 3T 2.5 BL		20	2428860000
AEB 35 SC/1		50	1991920000
AEB 35 SCL/1 VO		50	2661280000
ATPG 1.5-10 L		50	1991890000
ATPG 2.5 MI-R		50	1991960000
ATPG 2.5/3		25	2041190000
ATPG 2.5/5		25	2041180000
PS 2.0 MC		20	0310000000
SDIL 0,6x3,5x100		1	9042110000
DEK 5/5 PLUS MC NE WS		1000	1854490000
DEK 5/5 MM WS		800	2007110000
WS 8/5 MM WS		800	2007150000
WS 10/5 M PLUS MC NE WS		600	2003770000
SNAPMARK I		50	1805880000

All MultiMark variants (MM) = strip markers

A3T 2.5 FT-FT-PE

2.5 mm²

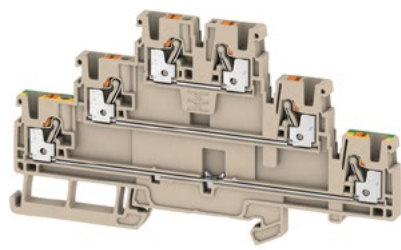

5.1 x 116 x 64.5
24 / 2.5
0.14...2.5

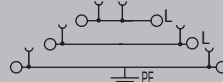

DIN EN 60947-7-1, DIN EN 60947-7-2

IEC	UL	CSA	EN 60079-7
800	300		
24	20		
2.5	AWG 28...12		
			8 kV / 3
			A3 / V-0



Rated connection

0.5...2.5 / 0.5...2.5
0.5...2.5 / 0.5...2.5
10 / 0.6 x 3.5 mm

Approval in progress

Type	Qty.	Order No.
A3T 2.5 FT-FT-PE	50	2428530000

Type	current	Qty.	Order No.
ZQV 2.5N/2	24 A	60	1527540000
ZQV 2.5N/10	24 A	20	1527690000
AEP 3T 2.5		20	2428560000
AEP 3T 2.5 BL		20	2428860000
AEB 35 SC/1		50	1991920000
AEB 35 SCL/1 VO		50	2661280000
ATPG 1.5-10 L		50	1991890000
ATPG 2.5 MI-R		50	1991960000
ATPG 2.5/3		25	2041190000
ATPG 2.5/5		25	2041180000
PS 2.0 MC		20	0310000000
SDIL 0,6x3,5x100		1	9042110000
DEK 5/5 PLUS MC NE WS		1000	1854490000
DEK 5/5 MM WS		800	2007110000
WS 8/5 MM WS		800	2007150000
WS 10/5 M PLUS MC NE WS		600	2003770000
SNAPMARK I		50	1805880000

All MultiMark variants (MM) = strip markers

A3T 2.5 N-FT-PE

2.5 mm²

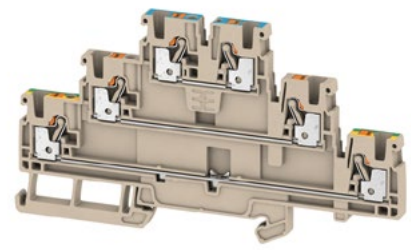

5.1 x 116 x 64.5
24 / 2.5
0.14...2.5

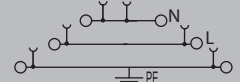

DIN EN 60947-7-1, DIN EN 60947-7-2

IEC	UL	CSA	EN 60079-7
800	300		
24	20		
2.5	AWG 28...12		
			8 kV / 3
			A3 / V-0



Rated connection

0.5...2.5 / 0.5...2.5
0.5...2.5 / 0.5...2.5
10 / 0.6 x 3.5 mm

Approval in progress

Type	Qty.	Order No.
A3T 2.5 N-FT-PE	50	2428840000

Type	current	Qty.	Order No.
ZQV 2.5N/2	24 A	60	1527540000
ZQV 2.5N/10	24 A	20	1527690000
AEP 3T 2.5		20	2428560000
AEP 3T 2.5 BL		20	2428860000
AEB 35 SC/1		50	1991920000
AEB 35 SCL/1 VO		50	2661280000
ATPG 1.5-10 L		50	1991890000
ATPG 2.5 MI-R		50	1991960000
ATPG 2.5/3		25	2041190000
ATPG 2.5/5		25	2041180000
PS 2.0 MC		20	0310000000
SDIL 0,6x3,5x100		1	9042110000
DEK 5/5 PLUS MC NE WS		1000	1854490000
DEK 5/5 MM WS		800	2007110000
WS 8/5 MM WS		800	2007150000
WS 10/5 M PLUS MC NE WS		600	2003770000
SNAPMARK I		50	1805880000

All MultiMark variants (MM) = strip markers



Spring connection with PUSH IN technology (A-Series)

Feed-through terminal blocks



AMC 2.5

2.5 mm²



AMC 2.5 800 V

2.5 mm²



Width/Height/Depth	mm
max. current / max. cond. cross-section	A/mm ²
Max. clamping range	mm ²

5.1 x 107.5 x 88
21 / 2.5
0.14...2.5

6.1 x 107.5 x 88
21 / 2.5
0.14...2.5

Technical data

Rated data	
Rated voltage	V
Rated current	A
for wire cross-section	mm ²
Rated impulse withstand voltage / Pollution severity	
Gauge to IEC 60947-1 / UL 94 flammability rating	
Approvals	
Clamped conductors (H05V/H07V)	
Solid / Stranded	mm ²
Flexible / Flexible with ferrule	mm ²
Stripping length / Blade size	mm/-
Note	

DIN EN 60947-7-1, DIN EN 60947-7-2

IEC	UL	CSA	EN 60079-7
690	150		
22	20		
2.5	AWG 28...12		
8 kV / 3			
A3 / V-0			

CE, VDE, IEC

Rated connection	
0.5...2.5 / 0.5...2.5	mm ²
0.5...2.5 / 0.5...2.5	mm ²
10 / 0.6 x 3.5 mm	mm/-

Approval in progress

DIN EN 60947-7-1, DIN EN 60947-7-2

IEC	UL	CSA	EN 60079-7
800	600		
22	20		
2.5	AWG 28...12		
8 kV / 3			
A3 / V-0			

CE, VDE, IEC

Rated connection	
0.5...2.5 / 0.5...2.5	mm ²
0.5...2.5 / 0.5...2.5	mm ²
10 / 0.6 x 3.5 mm	mm/-

Approval in progress

Ordering data

Version	
	dark beige
Note	

Type	Qty.	Order No.
AMC 2.5	50	2434340000

Type	Qty.	Order No.
AMC 2.5 800V	50	2434370000

Accessories

Pluggable cross-connection	
	2-pole
	10-pole
Vertical jumpers	
	1-pole
End plate	
	dark beige
End bracket	
	dark beige
	dark beige
Test plug	
Screwdriver	
	Standard
Identification systems	

Type	current	Qty.	Order No.
ZQV 2.5N/2	24 A	60	1527540000
ZQV 2.5N/10	24 A	20	1527690000
ZVQ 2.5/1.5	23 A	50	1720700000
AEP MC 2.5		25	2433820000
AEB 35 SC/1		50	1991920000
AEB 35 SCL/1 VO		50	2661280000
PS 2.0 MC		20	0310000000
SDIL 0,6x3,5x100		1	9042110000
DEK 5/5 PLUS MC NE WS		1000	1854490000
DEK 5/5 MM WS		800	2007110000
WS 8/5 MM WS		800	2007150000
WS 10/5 M PLUS MC NE WS		600	2003770000
SNAPMARK I		50	1805880000

Type	current	Qty.	Order No.
ZVQ 2.5/1.5	23 A	50	1720700000
AEB 35 SC/1		50	1991920000
AEB 35 SCL/1 VO		50	2661280000
PS 2.0 MC		20	0310000000
SDIL 0,6x3,5x100		1	9042110000
DEK 5/5 PLUS MC NE WS		1000	1854490000
DEK 5/5 MM WS		800	2007110000
WS 8/5 MM WS		800	2007150000
WS 10/5 M PLUS MC NE WS		600	2003770000
SNAPMARK I		50	1805880000

For detailed information on other accessories and application in the online catalogue

All MultiMark variants (MM) = strip markers

All MultiMark variants (MM) = strip markers



Spring connection with PUSH IN technology (A-Series)
PE terminal blocks

Universal range

A



A2C 1.5 PE

1.5 mm²

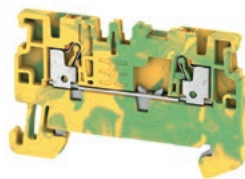

A3C 1.5 PE

1.5 mm²

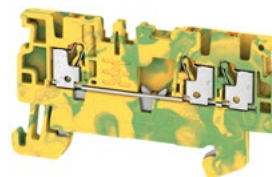

Width/Height/Depth	mm
max. current / max. cond. cross-section	-/mm ²
Max. clamping range	mm ²

3.5 x 55 x 33.5	
/ 1.5	
0.14...1.5	

3.5 x 61.5 x 33.5	
/ 1.5	
0.14...1.5	

Technical data

Rated data	
for wire cross-section	mm ²
Rated voltage to adjoining terminal	V
Rated impulse withstand voltage to adjacent terminal	kV
Rated short-time current	
Pollution severity	
Gauge to IEC 60947-1 / UL 94 flammability rating	
Approvals	
Clamped conductors (H05V/H07V)	
Solid / Stranded	mm ²
Flexible / Flexible with ferrule	mm ²
Stripping length / Blade size	mm/-

IEC 60947-7-2			
IEC	UL	CSA	EN 60079-7
1.5	AWG 26...14		1.5 mm ²
500			
6			
180 A (1.5 mm ²)			
3			
A1 / V-0			
Rated connection			
0.5...1.5 / 0.5...1.5			
0.5...1.5 / 0.5...1			
8 / 0.4 x 2.0 mm			

IEC 60947-7-2			
IEC	UL	CSA	EN 60079-7
1.5	AWG 26...14		1.5 mm ²
500			
6			
180 A (1.5 mm ²)			
3			
A1 / V-0			
Rated connection			
0.5...1.5 / 0.5...1.5			
0.5...1.5 / 0.5...1			
8 / 0.4 x 2.0 mm			

Note

Approval in progress

Approval in progress

Ordering data

Version	green/yellow
Note	

Type	Qty.	Order No.
A2C 1.5 PE	50	1552680000

Type	Qty.	Order No.
A3C 1.5 PE	50	1552670000

Accessories

Accessories	Color
End plate	dark beige
End bracket	dark beige
Test adapter	1-pole stackable, 3-pole, 5-pole
Test plug	
Screwdriver	Standard
Identification systems	

Type	current	Qty.	Order No.
AEP 2C 1.5		50	1552600000
AEB 35 SC/1		50	1991920000
AEB 35 SCL/1 VO		50	2661280000
ATPG 1.5-10 L		50	1991890000
ATPG 1.5 MI-R		50	1991880000
PS 2.0 MC		20	0310000000
SDS 0.4X2.0X60		1	9037160000
WS 10/3.5 PLUS MC NE WS		960	2003760000
DEK 5/3.5 MM WS		1000	2007100000
WS 8/3.5 MM WS		1000	2007140000
DEK 5/3.5 PLUS MC NE WS		1600	2003750000

Type	current	Qty.	Order No.
AEP 3C 1.5		50	1552620000
AEB 35 SC/1		50	1991920000
AEB 35 SCL/1 VO		50	2661280000
ATPG 1.5-10 L		50	1991890000
ATPG 1.5 MI-R		50	1991880000
PS 2.0 MC		20	0310000000
SDS 0.4X2.0X60		1	9037160000
WS 10/3.5 PLUS MC NE WS		960	2003760000
DEK 5/3.5 MM WS		1000	2007100000
WS 8/3.5 MM WS		1000	2007140000
DEK 5/3.5 PLUS MC NE WS		1600	2003750000

For detailed information on other accessories and application in the online catalogue

All MultiMark variants (MM) = strip markers

All MultiMark variants (MM) = strip markers

A4C 1.5 PE

1.5 mm²

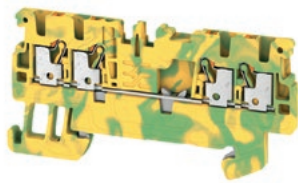

3.5 x 67.5 x 33.5
/ 1.5
0.14...1.5



IEC 60947-7-2

IEC	UL	CSA	EN 60079-7
1.5	AWG 26...14		1.5 mm ²
500			
6			
	180 A (1.5 mm ²)		
	3		
	A1 / V-0		

CE, RoHS, REACH, ENEC

Rated connection

0.5...1.5 / 0.5...1.5

0.5...1.5 / 0.5...1

8 / 0.4 x 2.0 mm

Approval in progress

Type	Qty.	Order No.
A4C 1.5 PE	50	1552660000

Type	current	Qty.	Order No.
AEP 4C 1.5		50	1552640000
AEB 35 SC/1		50	1991920000
AEB 35 SCL/1 VO		50	2661280000
ATPG 1.5-10 L		50	1991890000
ATPG 1.5 MI-R		50	1991880000
PS 2.0 MC		20	0310000000
SDS 0.4X2.0X60		1	9037160000
WS 10/3.5 PLUS MC NE WS	960		2003760000
DEK 5/3.5 MM WS	1000		2007100000
WS 8/3.5 MM WS	1000		2007140000
DEK 5/3.5 PLUS MC NE WS	1600		2003750000

All MultiMark variants (MM) = strip markers

A2C 2.5 PE

2.5 mm²

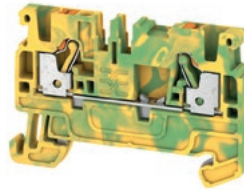

5.1 x 55 x 36.5
/ 2.5
0.14...2.5

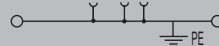

IEC 60947-7-2

IEC	UL	CSA	EN 60079-7
2.5	AWG 28...12	AWG 28...12	2.5 mm ²
800			
8			
	300 A (2.5 mm ²)		
	3		
	A3 / V-0		

CE, RoHS, REACH, ENEC

Rated connection

0.5...2.5 / 0.5...2.5

0.5...2.5 / 0.5...2.5

10 / 0.6 x 3.5 mm

Approval in progress

Type	Qty.	Order No.
A2C 2.5 PE	50	1521680000

Type	current	Qty.	Order No.
AEP 2C 2.5		50	1514400000
AEB 35 SC/1		50	1991920000
AEB 35 SCL/1 VO		50	2661280000
ATPG 1.5-10 L		50	1991890000
ATPG 2.5 MI-R		50	1991960000
ATPG 2.5/3		25	2041190000
ATPG 2.5/5		25	2041180000
PS 2.0 MC		20	0310000000
SDIL 0,6x3,5x100		1	9042110000
DEK 5/5 PLUS MC NE WS	1000		1854490000
DEK 5/5 MM WS	800		2007110000
WS 8/5 MM WS	800		2007150000
WS 10/5 M PLUS MC NE WS	600		2003770000

All MultiMark variants (MM) = strip markers

A3C 2.5 PE

2.5 mm²

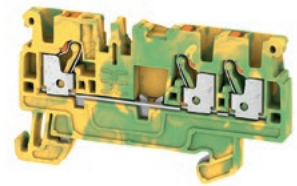

5.1 x 66.5 x 36.5
/ 2.5
0.14...2.5



IEC 60947-7-2

IEC	UL	CSA	EN 60079-7
2.5	AWG 28...12	AWG 28...12	2.5 mm ²
800			
8			
	300 A (2.5 mm ²)		
	3		
	A3 / V-0		

CE, RoHS, REACH, ENEC

Rated connection

0.5...2.5 / 0.5...2.5

0.5...2.5 / 0.5...2.5

10 / 0.6 x 3.5 mm

Approval in progress

Type	Qty.	Order No.
A3C 2.5 PE	50	1521670000

Type	current	Qty.	Order No.
AEP 3C 2.5		50	1521510000
AEB 35 SC/1		50	1991920000
AEB 35 SCL/1 VO		50	2661280000
ATPG 1.5-10 L		50	1991890000
ATPG 2.5 MI-R		50	1991960000
ATPG 2.5/3		25	2041190000
ATPG 2.5/5		25	2041180000
PS 2.0 MC		20	0310000000
SDIL 0,6x3,5x100		1	9042110000
DEK 5/5 PLUS MC NE WS	1000		1854490000
DEK 5/5 MM WS	800		2007110000
WS 8/5 MM WS	800		2007150000
WS 10/5 M PLUS MC NE WS	600		2003770000

All MultiMark variants (MM) = strip markers



Spring connection with PUSH IN technology (A-Series)
PE terminal blocks

Universal range

A



A4C 2.5 PE

2.5 mm²



A2C 4 PE

4 mm²



Width/Height/Depth	mm
max. current / max. cond. cross-section	-/mm ²
Max. clamping range	mm ²

5.1 x 77.5 x 36.5	
/ 2.5	
0.14...2.5	

6.1 x 60 x 39.5	
/ 4	
0.5...4	

Technical data

Rated data	
for wire cross-section	mm ²
Rated voltage to adjoining terminal	V
Rated impulse withstand voltage to adjacent terminal	kV
Rated short-time current	
Pollution severity	
Gauge to IEC 60947-1 / UL 94 flammability rating	
Approvals	
Clamped conductors (H05V/H07V)	
Solid / Stranded	mm ²
Flexible / Flexible with ferrule	mm ²
Stripping length / Blade size	mm/-

IEC 60947-7-2			
IEC	UL	CSA	EN 60079-7
2.5	AWG 28...12	AWG 28...12	2.5 mm ²
800			
8			
	300 A (2.5 mm ²)		
	3		
	A3 / V-0		
Rated connection			
0.5...2.5 / 0.5...2.5			
0.5...2.5 / 0.5...2.5			
10 / 0.6 x 3.5 mm			

IEC 60947-7-2			
IEC	UL	CSA	EN 60079-7
4	AWG 28...10	AWG 26...10	4 mm ²
800			
8			
	480 A (4 mm ²)		
	3		
	A4 / V-0		
Rated connection			
0.5...4 / 0.5...4			
0.5...4 / 0.5...4			
12 / 0.6 x 3.5 mm			

Note

Approval in progress

Approval in progress

Ordering data

Version	
	green/yellow
Note	

Type	Qty.	Order No.
A4C 2.5 PE	50	1521540000

Type	Qty.	Order No.
A2C 4 PE	50	2051360000

Accessories

End plate	dark beige
End bracket	dark beige
	dark beige
Test adapter	1-pole
	stackable
	3-pole
	5-pole
Test plug	
Screwdriver	Standard
Identification systems	

Type	current	Qty.	Order No.
AEP 4C 2.5		50	1521530000
AEB 35 SC/1		50	1991920000
AEB 35 SCL/1 VO		50	2661280000
ATPG 1.5-10 L		50	1991890000
ATPG 2.5 MHR		50	1991960000
ATPG 2.5/3		25	2041190000
ATPG 2.5/5		25	2041180000
PS 2.0 MC		20	0310000000
SDIL 0,6x3,5x100		1	9042110000
DEK 5/5 PLUS MC NE WS	1000		1854490000
DEK 5/5 MM WS	800		2007110000
WS 8/5 MM WS	800		2007150000
WS 10/5 M PLUS MC NE WS	600		2003770000

Type	current	Qty.	Order No.
AEP 2C 4		50	2051680000
AEB 35 SC/1		50	1991920000
AEB 35 SCL/1 VO		50	2661280000
ATPG 1.5-10 L		50	1991890000
ATPG 4 MHR		50	1991860000
PS 2.0 MC		20	0310000000
SDIL 0,6x3,5x100		1	9042110000
WS 10/6 M PLUS MC NE WS	600		2003780000
DEK 5/6 MM WS	600		2007120000
WS 8/6 MM WS	600		2007160000
DEK 5/6 PLUS MC NE WS	1000		1011320000

For detailed information on other accessories and application in the online catalogue

All MultiMark variants (MM) = strip markers

All MultiMark variants (MM) = strip markers

A3C 4 PE

4 mm²

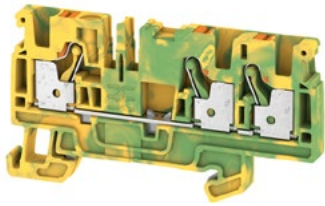

6.1 x 74 x 39.5
/ 4
0.5...4

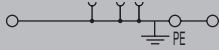

IEC 60947-7-2

IEC	UL	CSA	EN 60079-7
4	AWG 28...10	AWG 26...10	4 mm ²
800			
8			
	480 A (4 mm ²)		
	3		
	A4 / V-0		

CE

Rated connection

0.5...4 / 0.5...4

0.5...4 / 0.5...4

12 / 0.6 x 3.5 mm

Approval in progress

Type	Qty.	Order No.
A3C 4 PE	50	2051410000

Type	current	Qty.	Order No.
AEP 3C 4		20	2051720000
AEB 35 SC/1		50	1991920000
AEB 35 SCL/1 VO		50	2661280000
ATPG 1.5-10 L		50	1991890000
ATPG 4 MHR		50	1991860000
PS 2.0 MC		20	0310000000
SDIL 0,6x3,5x100		1	9042110000
WS 10/6 M PLUS MC NE WS	600		2003780000
DEK 5/6 MM WS	600		2007120000
WS 8/6 MM WS	600		2007160000
DEK 5/6 PLUS MC NE WS	1000		1011320000

All MultiMark variants (MM) = strip markers

A4C 4 PE

4 mm²

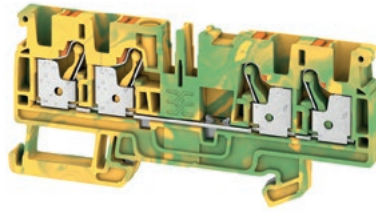

6.1 x 87.5 x 39.5
/ 4
0.5...4

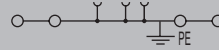

IEC 60947-7-2

IEC	UL	CSA	EN 60079-7
4	AWG 28...10	AWG 26...10	4 mm ²
800			
8			
	480 A (4 mm ²)		
	3		
	A4 / V-0		

CE

Rated connection

0.5...4 / 0.5...4

0.5...4 / 0.5...4

12 / 0.6 x 3.5 mm

Approval in progress

Type	Qty.	Order No.
A4C 4 PE	50	2051560000

Type	current	Qty.	Order No.
AEP 4C 4		20	2051900000
AEB 35 SC/1		50	1991920000
AEB 35 SCL/1 VO		50	2661280000
ATPG 1.5-10 L		50	1991890000
ATPG 4 MHR		50	1991860000
PS 2.0 MC		20	0310000000
SDIL 0,6x3,5x100		1	9042110000
WS 10/6 M PLUS MC NE WS	600		2003780000
DEK 5/6 MM WS	600		2007120000
WS 8/6 MM WS	600		2007160000
DEK 5/6 PLUS MC NE WS	1000		1011320000

All MultiMark variants (MM) = strip markers

A2C 6 PE

6 mm²



8.1 x 66.5 x 45.5
/ 6
0.5...6

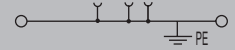

IEC 60947-7-2

IEC	UL	CSA	EN 60079-7
6	AWG 22...8	AWG 22...8	6 mm ²
800			
8			
	720 A (6 mm ²)		
	3		
	A5 / V-0		

CE

Rated connection

0.5...6 / 0.5...6

0.5...6 / 0.5...6

12 / 1.0 x 5.5 mm

Approval in progress

Type	Qty.	Order No.
A2C 6 PE	50	1991810000

Type	current	Qty.	Order No.
AEP 2C 6		50	1991970000
AEB 35 SC/1		50	1991920000
AEB 35 SCL/1 VO		50	2661280000
ATPG 1.5-10 L		50	1991890000
ATPG 6 MHR		50	1991930000
PS 2.0 MC		20	0310000000
SDIL 1,0x5,5x125		1	9042130000
DEK-A 5/8 MM WS	500		2448860000
DEK 5/8 PLUS MC NE WS	800		1046350000
WS-A 8/8 MM WS	500		2448930000
WS 10/8 PLUS MC NE WS	420		1905950000

All MultiMark variants (MM) = strip markers



Spring connection with PUSH IN technology (A-Series)
PE terminal blocks



A3C 6 PE

6 mm²

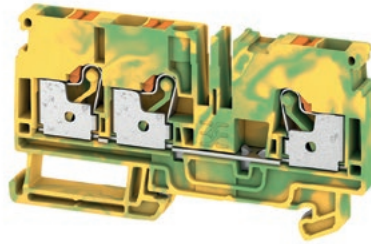

A2C 10 PE

10 mm²



Width/Height/Depth	mm
max. current / max. cond. cross-section	-/mm ²
Max. clamping range	mm ²

8.1 x 84.5 x 45.5	
/ 6	
0.5...6	

10 x 80.5 x 51.5	
/ 10	
0.5...10	

Technical data

Rated data	
for wire cross-section	mm ²
Rated voltage to adjoining terminal	V
Rated impulse withstand voltage to adjacent terminal	kV
Rated short-time current	
Pollution severity	
Gauge to IEC 60947-1 / UL 94 flammability rating	
Approvals	
Clamped conductors (H05V/H07V)	
Solid / Stranded	mm ²
Flexible / Flexible with ferrule	mm ²
Stripping length / Blade size	mm/-
Note	

IEC 60947-7-2

IEC	UL	CSA	EN 60079-7
6	AWG 22...8	AWG 22...8	6 mm ²
800			
8			
	720 A (6 mm ²)		
	3		
	A5 / V-0		

CE

Rated connection	
0.5...6 / 0.5...6	
0.5...6 / 0.5...6	
12 / 1.0 x 5.5 mm	

Approval in progress

IEC 60947-7-2

IEC	UL	CSA	EN 60079-7
10			
	3		
	A6 / V-0		

IEC

Rated connection	
0.5...10 / 0.5...10	
0.5...10 / 0.5...10	
18 / 1.0 x 5.5 mm	

Approval in progress

Ordering data

Version	green/yellow
Note	

Type	Qty.	Order No.
A3C 6 PE	50	1991850000

Type	Qty.	Order No.
A2C 10 PE	25	2490440000

Accessories

End plate	dark beige
End bracket	dark beige
Test adapter	1-pole stackable
Test plug	
Screwdriver	Standard
Identification systems	

Type	current	Qty.	Order No.
AEP 3C 6		50	1991940000
AEB 35 SC/1		50	1991920000
AEB 35 SCL/1 V0		50	2661280000
ATPG 1.5-10 L		50	1991890000
ATPG 6 MHR		50	1991930000
PS 2.0 MC		20	0310000000
SDIL 1,0x5,5x125		1	9042130000
DEK-A 5/8 MM WS		500	2448860000
DEK 5/8 PLUS MC NE WS		800	1046350000
WS-A 8/8 MM WS		500	2448930000
WS 10/8 PLUS MC NE WS		420	1905950000

Type	current	Qty.	Order No.
AEP 2C 10/16		20	2490380000
AEB 35 SC/1		50	1991920000
AEB 35 SCL/1 V0		50	2661280000
PS 2.0 MC		20	0310000000
WS 7.8/9.2 PLUS MC NE GR		360	1208970000

For detailed information on other accessories and application in the online catalogue

All MultiMark variants (MM) = strip markers

All MultiMark variants (MM) = strip markers

A3C 10 PE

10 mm²

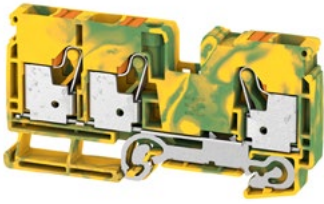

10 x 102 x 51.5
/ 10
0.5...10

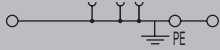

IEC 60947-7-2

IEC	UL	CSA	EN 60079-7
10			

3
A6 / V-0

EH

Rated connection

0.5...10 / 0.5...10
0.5...10 / 0.5...10
18 / 1.0 x 5.5 mm

Approval in progress

Type	Qty.	Order No.
A3C 10 PE	25	2490590000

Type	current	Qty.	Order No.
AEP 3C 10/16		20	2490530000
AEB 35 SC/1		50	1991920000
AEB 35 SCL/1 VO		50	2661280000
PS 2.0 MC		20	0310000000
WS 7.8/9.2 PLUS MC NE GR		360	1208970000

All MultiMark variants (MM) = strip markers

A2C 16 PE

16 mm²



12 x 80.5 x 51.5
/ 16
0.75...16



IEC 60947-7-2

IEC	UL	CSA	EN 60079-7
16			

3
A6 / V-0

EH

Rated connection

0.75...10 / 0.75...16
0.75...16 / 1.5...16
18 / 1.0 x 5.5 mm

Approval in progress

Type	Qty.	Order No.
A2C 16 PE	20	2494010000

Type	current	Qty.	Order No.
AEP 2C 10/16		20	2490380000
AEB 35 SC/1		50	1991920000
AEB 35 SCL/1 VO		50	2661280000
PS 2.0 MC		20	0310000000
WS 7.8/9.2 PLUS MC NE GR		360	1208970000

All MultiMark variants (MM) = strip markers

A3C 16 PE

16 mm²



12 x 102 x 51.5
/ 16
0.75...16



IEC 60947-7-2

IEC	UL	CSA	EN 60079-7
16			

3
A6 / V-0

EH

Rated connection

0.75...10 / 0.75...16
0.75...16 / 1.5...16
18 / 1.0 x 5.5 mm

Approval in progress

Type	Qty.	Order No.
A3C 16 PE	20	2494020000

Type	current	Qty.	Order No.
AEP 3C 10/16		20	2490530000
AEB 35 SC/1		50	1991920000
AEB 35 SCL/1 VO		50	2661280000
PS 2.0 MC		20	0310000000
WS 7.8/9.2 PLUS MC NE GR		360	1208970000

All MultiMark variants (MM) = strip markers



Spring connection with PUSH IN technology (A-Series)
PE terminal blocks



A2C 35 PE

35 mm²



A2T 1.5 PE

1.5 mm²

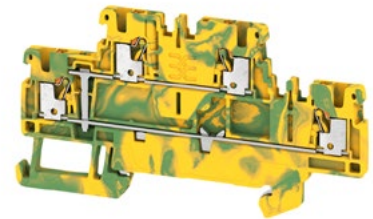

Width/Height/Depth	mm
max. current / max. cond. cross-section	-/mm ²
Max. clamping range	mm ²

16 x 101 x 71,5	
/ 35	
2,5...35	

3.5 x 84 x 45	
/ 1.5	
0.14...1.5	

Technical data

Rated data	
for wire cross-section	mm ²
Rated voltage to adjoining terminal	-
Rated impulse withstand voltage to adjacent terminal	-
Rated short-time current	
Pollution severity	
Gauge to IEC 60947-1 / UL 94 flammability rating	
Approvals	
Clamped conductors (H05V/H07V)	
Solid / Stranded	mm ²
Flexible / Flexible with ferrule	mm ²
Stripping length / Blade size	mm/-

IEC 60947-7-2			
IEC	UL	CSA	EN 60079-7
35			
1000			
8			
	4200 A (35 mm ²)		
	3		
	/ V-0		
C €			
Rated connection			
2,5...35 / 2,5...35			
10...35 / 0,5...35			
25 /			

IEC 60947-7-2			
IEC	UL	CSA	EN 60079-7
1.5	AWG 26...14		
		180 A (1.5 mm ²)	
		3	
		A1 / V-0	
UL 94			
Rated connection			
0.5...1.5 / 0.5...1.5			
0.5...1.5 / 0.5...1.5			
8 / 0.4 x 2.0 mm			

Note

Approval in progress

Approval in progress

Ordering data

Version	
	green/yellow
Note	

Type	Qty.	Order No.
A2C 35 PE	10	2551520000

Type	Qty.	Order No.
A2T 1.5 PE	50	2469410000

Accessories

End plate	dark beige
End bracket	dark beige
Test adapter	1-pole stackable
Test plug	
Screwdriver	Standard
Identification systems	

Type	current	Qty.	Order No.
AEB 35 SC/1		50	1991920000
AEB 35 SCL/1 VO		50	2661280000
ATPG 1.5-10 L		50	1991890000
PS 2.0 MC		20	0310000000
DEK 5/8 MC NE WS		800	1856740000
DEK 5/8 MM WS		500	2007130000
WS 8/8 MM WS		500	2007170000

Type	current	Qty.	Order No.
AEP 2T 1.5		20	2469420000
AEB 35 SC/1		50	1991920000
AEB 35 SCL/1 VO		50	2661280000
ATPG 1.5-10 L		50	1991890000
ATPG 1.5 MH-R		50	1991880000
PS 2.0 MC		20	0310000000
SDS 0.4X2.0X60		1	9037160000
WS 10/3.5 PLUS MC NE WS		960	2003760000
DEK 5/3.5 MM WS		1000	2007100000
WS 8/3.5 MM WS		1000	2007140000
DEK 5/3.5 PLUS MC NE WS		1600	2003750000
SNAPMARK I		50	1805880000

For detailed information on other accessories and application in the online catalogue

All MultiMark variants (MM) = strip markers

All MultiMark variants (MM) = strip markers

A2T 2.5 PE

2.5 mm²

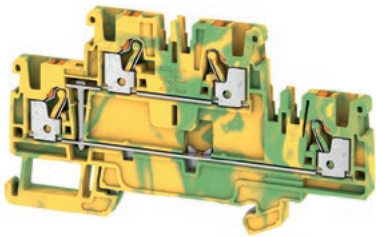

5.1 x 90 x 50.5
/ 2.5
0.14...2.5

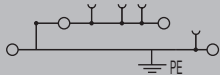

IEC 60947-7-2

IEC	UL	CSA	EN 60079-7
2.5	AWG 28...12	AWG 28...12	2.5 mm ²
800			
8			
300 A (2.5 mm ²)			
3			
A3 / V-0			

CE

Rated connection

0.5...2.5 / 0.5...2.5
0.5...2.5 / 0.5...2.5
10 / 0.6 x 3.5 mm

Approval in progress

Type	Qty.	Order No.
A2T 2.5 PE	50	1547680000

Type	current	Qty.	Order No.
AEP 2T 2.5		20	1547690000
AEB 35 SC/1		50	1991920000
AEB 35 SCL/1 VO		50	2661280000
ATPG 1.5-10 L		50	1991890000
ATPG 2.5 MI-R		50	1991960000
PS 2.0 MC		20	0310000000
SDIL 0,6x3,5x100		1	9042110000
DEK 5/5 PLUS MC NE WS	1000		1854490000
DEK 5/5 MM WS	800		2007110000
WS 8/5 MM WS	800		2007150000
WS 10/5 M PLUS MC NE WS	600		2003770000

All MultiMark variants (MM) = strip markers

A2T 2.5 3C PE

2.5 mm²



5.1 x 114.2 x 64
/ 2.5
0.14...2.5

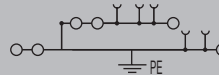

IEC 60947-7-2

IEC	UL	CSA	EN 60079-7
2.5			
800			
8			
300 A (2.5 mm ²)			
3			
A3 / V-0			

Rated connection

0.5...2.5 / 0.5...2.5
0.5...2.5 / 0.5...2.5
10 / 0.6 x 3.5 mm

Approval in progress

Type	Qty.	Order No.
A2T 2.5 3C PE	50	2531320000

Type	current	Qty.	Order No.
AEP 2T 2.5 3C		20	2532690000
AEB 35 SC/1		50	1991920000
AEB 35 SCL/1 VO		50	2661280000
ATPG 1.5-10 L		50	1991890000
ATPG 2.5 MI-R		50	1991960000
PS 2.0 MC		20	0310000000
SDIL 0,6x3,5x100		1	9042110000
DEK 5/5 PLUS MC NE WS	1000		1854490000
DEK 5/5 MM WS	800		2007110000
WS 8/5 MM WS	800		2007150000
WS 10/5 M PLUS MC NE WS	600		2003770000

All MultiMark variants (MM) = strip markers

A2T 4 PE

4 mm²

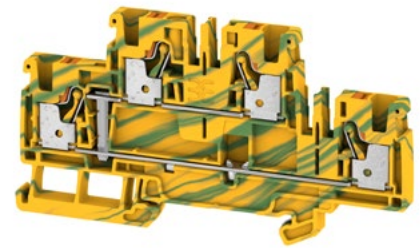

6.1 x 100 x 53.5
/ 4
0,14...4

IEC 60947-7-2

IEC	UL	CSA	EN 60079-7
4	AWG 26...10		
800	600		
8	8		
480 A (4 mm ²)			
3			
A4 / V-0			

CE

Rated connection

0,5...4 / 0,5...4
0,5...4 / 0,5...4
12 / 0,6 x 3,5 mm

Approval in progress

Type	Qty.	Order No.
A2T 4 PE	50	2539990000

Type	current	Qty.	Order No.
AEP 2T 4		20	2540000000
AEB 35 SC/1		50	1991920000
AEB 35 SCL/1 VO		50	2661280000
ATPG 1.5-10 L		50	1991890000
ATPG 4 MI-R		50	1991860000
PS 2.0 MC		20	0310000000
SDIL 0,6x3,5x100		1	9042110000
DEK 5/6 PLUS MC NE WS	1000		1011320000
WS 8/6 MM WS	600		2007160000
DEK 5/6 MM WS	600		2007120000
WS 10/6 M PLUS MC NE WS	600		2003780000

All MultiMark variants (MM) = strip markers



Spring connection with PUSH IN technology (A-Series) PE terminal blocks

Universal range

A



A3T 2.5 PE

2.5 mm²

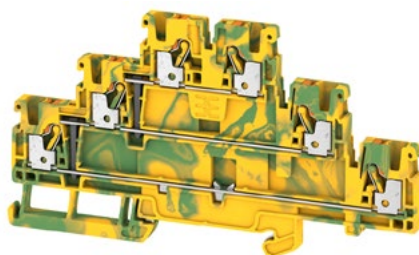

Width/Height/Depth	mm
max. current / max. cond. cross-section	-/mm ²
Max. clamping range	mm ²

5.1 x 116 x 64.5
/ 2.5
0.14...2.5

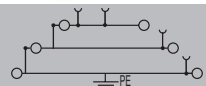

Technical data

Rated data	
for wire cross-section	mm ²
Rated voltage to adjoining terminal	-
Rated impulse withstand voltage to adjacent terminal	kV
Rated short-time current	
Pollution severity	
Gauge to IEC 60947-1 / UL 94 flammability rating	
Approvals	
Clamped conductors (H05V/H07V)	
Solid / Stranded	mm ²
Flexible / Flexible with ferrule	mm ²
Stripping length / Blade size	mm/-

DIN EN 60947-7-2

IEC	UL	CSA	EN 60079-7
2.5	AWG 28...12		
8			
	300 A (2.5 mm ²)		
	3		
	A3 / V-0		

UL

Rated connection	
0.5...2.5 / 0.5...2.5	
0.5...2.5 / 0.5...2.5	
10 / 0.6 x 3.5 mm	

Note

Approval in progress

Ordering data

Version	green/yellow
Note	

Type	Qty.	Order No.
A3T 2.5 PE	50	2428560000

Accessories

End plate	dark beige
End bracket	dark beige
Test adapter	1-pole stackable
Test plug	
Screwdriver	Standard
Identification systems	

Type	current	Qty.	Order No.
AEP 3T 2.5		20	2428560000
AEB 35 SC/1		50	1991920000
AEB 35 SCL/1 V0		50	2661280000
ATPG 1.5-10 L		50	1991890000
ATPG 2.5 M/R		50	1991960000
PS 2.0 MC		20	0310000000
SDIL 0,6x3,5x100		1	9042110000
DEK 5/5 PLUS MC NE WS		1000	1854490000
DEK 5/5 MM WS		800	2007110000
WS 8/5 MM WS		800	2007150000
WS 10/5 M PLUS MC NE WS		600	2003770000

For detailed information on other accessories and application in the online catalogue

All MultiMark variants (MM) = strip markers





Safety, protection and reliable disconnection of electrical circuits Klippon® Connect combines protective functions and quick assembly

Current protection, disconnection, and voltage distribution are critical functions inside a panel. In order to provide staff and machinery with optimal protection, customisable connection solutions have to combine these aspects within a single system.

The new Klippon® Connect disconnect and fuse terminal blocks with PUSH IN technology offer passive current protection in combination with both disconnection and voltage distribution.

The terminal blocks from our universal range guarantee a high level of flexibility. Their compact dimensions enable a flexible installation even under confined space conditions.

Functional clarity

In terms of their design, the terminal blocks are clearly distinguishable according to functionality and thus ensure safe and efficient maintenance work.

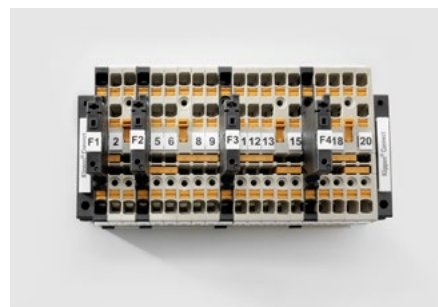



Attached fuse holder

Each fuse holder is attached to a terminal block with a hinge. This means that it will not go missing when the circuit is disconnected or when a fuse is replaced.



Integrated test point

The integrated test point simplifies troubleshooting and maintenance: Any required measurements can be performed with a standard 2.0 mm testing plug.



Safe power supply to panel equipment

For an efficient control voltage distribution, Weidmüller offers potential distribution terminal blocks with and without fuse.

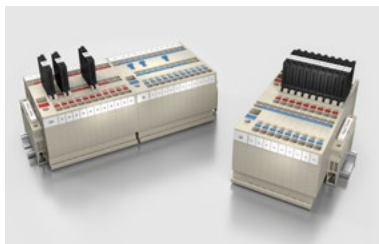

Spring connection with PUSH IN technology (A series)
Fuse terminal blocks

AFS 2.5 CF 2C

2.5 mm²

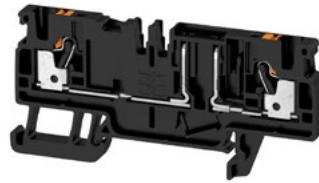

Width/Height/Depth	mm
max. current / max. cond. cross-section	A/mm ²
Max. clamping range	mm ²

5.1 x 77.5 x 37.65
10 / 2.5
2.5...2.5

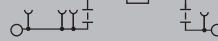

Technical data

Rated data	
Rated voltage to adjoining terminal	V
Rated current	A
for wire cross-section	mm ²
Rated impulse withstand voltage / Pollution severity	
Gauge to IEC 60947-1 / UL 94 flammability rating	
Approvals	
Clamped conductors (H05V/H07V)	
Solid / Stranded	mm ²
Flexible / Flexible with ferrule	mm ²
Stripping length / Blade size	
Note	

In accordance with IEC 60947-7-3

IEC	UL	CSA	EN 60079-7
500			
10			
2.5			
	/ 3		
	A3 /		
Rated connection			
0.5...2.5 / 0.5...2.5			
0.5...2.5 / 0.5...2.5			
10 / 0.6 x 3.5 mm			
Note			
The electrical data are determined by the fuse and fault indication.			

Dimensions for blade-type fuse inserts according to
DIN 72581-3:2001-03

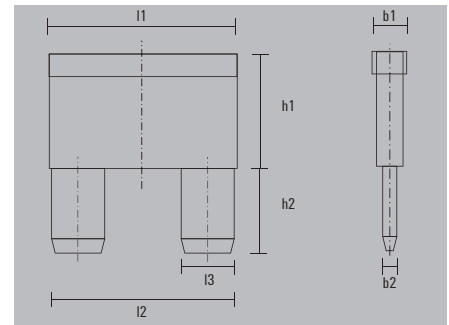

b1 max.	b2 ± 0.4	h1 max.	h2 ± 0.2	l1 max.	l2 ± 0.3	l3 ± 0.2
4	0.82	9	7.5	12	10.9	2.8

dimensions in mm

Ordering data

Version	
	400 V DC
	12 V DC
	24 V DC
Note	

Type	Qty.	Order No.
AFS 2.5 CF 2C BK	50	2466530000
AFS 2.5 CF 2C 12V BK	50	2466610000
AFS 2.5 CF 2C 24V BK	50	2466600000
Note		
Blade-fuse inserts: from 42 V observe protection against contact.		

Accessories

Pluggable cross-connection	
	2-pole
	10-pole
End plate	
	Black
Test plug	
Terminal blocks identical in contour	
Screwdriver	Standard
Identification systems	

Type	current	Qty.	Order No.
ZQV 2.5N/2	24 A	60	1527540000
ZQV 2.5N/10	24 A	20	1527690000
AEP 4C 2.5 BK		50	2486660000
PS 2.0 MC		20	0310000000
A3C 2.5		100	1521740000
A3C 2.5 PE		50	1521670000
ADT 2.5 2C		50	1989800000
A2C 2.5 /DT/FS		100	1989900000
A2C 2.5 PE /DT/FS		50	1989890000
SDIL 0,6x3,5x100		1	9042110000
DEK 5/5 PLUS MC NE WS		1000	1854490000
WS 10/5 M PLUS MC NE WS		600	2003770000
DEK 5/5 MM WS		800	2007110000
WS 8/5 MM WS		800	2007150000

For detailed information on other accessories and application in the online catalogue

AFS 4 2C

4 mm²



Width/Height/Depth	mm
max. current / max. cond. cross-section	A/mm ²
Max. clamping range	mm ²

6.1 x 74 x 68
6.3 / 4
0.5...4



Technical data

Rated data	
Rated voltage to adjoining terminal	V
Rated current	A
for wire cross-section	mm ²
Rated impulse withstand voltage / Pollution severity	
Gauge to IEC 60947-1 / UL 94 flammability rating	
Approvals	
Clamped conductors (H05V/H07V)	
Solid / Stranded	mm ²
Flexible / Flexible with ferrule	mm ²
Stripping length / Blade size	
Note	

DIN EN 60947-7-3

IEC	UL	CSA	EN 60079-7
500	150 (C)		
6.3	10		
4	AWG 26...10		
/ 3			
A4 / V-0			
UL			
Rated connection			
0.5...4 / 0.5...4			
0.5...4 / 0.5...4			
12 / 0.6 x 3.5 mm			

Arrangement	Applications			
	Only short-circuit protection		Overload	
	T _A max.	Nominal values	T _A max.	Nominal values
Individual	41 °C*	4,0 W / 6,3 A*	31 °C	1,6 W / 6,3 A
In combination	32 °C*	2,5 W / 6,3 A	34 °C	1,6 W / 6,3 A

Ordering data

Version	
	500 V AC/DC, without LED
	10-36 V AC/DC, with LED
	30-70 V AC/DC, with LED
	60-150 V AC/DC, with LED
	100-250 V AC/DC, with LED
Note	

Type	Qty.	Order No.
AFS 4 2C BK	50	2429860000
AFS 4 2C 10-36V BK	50	2429870000
AFS 4 2C 30-70V BK	50	2434350000
AFS 4 2C 60-150V BK	50	2434380000
AFS 4 2C 100-250V BK	50	2434390000

Accessories

Pluggable cross-connection	
	2-pole
	10-pole
End plate	
	Black
Test plug	
Terminal blocks identical in contour	
Screwdriver	
	Standard
Identification systems	

Type	current	Qty.	Order No.
ZQV 4N/2	32 A	60	1527930000
ZQV 4N/10	32 A	20	1528090000
AEP 3C 4 BK		20	2486640000
PS 2.0 MC		20	0310000000
A3C 4		50	2051240000
A3C 4 PE		50	2051410000
SDIL 0,6x3,5x100		1	9042110000
DEK 5/6 PLUS MC NE WS		1000	1011320000
WS 10/6 M PLUS MC NE WS		600	2003780000
DEK 5/6 MM WS		600	2007120000
WS 8/6 MM WS		600	2007160000
G 20/0.25A/F		10	0430500000
G 20/0.50A/F		10	0430600000
G 20/1.00A/F		10	0430700000
G 20/2.00A/F		10	0430900000

G-fuse cartridge, 5 x 20 mm (IEC 60127-2)	
	0.25 A fast
	0.50 A fast
	1.00 A fast
	2.00 A fast

For detailed information on other accessories and application in the online catalogue



Spring connection with PUSH IN technology (A series)
Fuse terminal blocks

AFS 4 2C BK/BL

4 mm²



Width/Height/Depth	mm
max. current / max. cond. cross-section	A/mm ²
Max. clamping range	mm ²

6.1 x 74 x 68
6.3 / 4
0.5...4

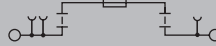

Technical data

Rated data	
Rated voltage to adjoining terminal	V
Rated current	A
for wire cross-section	mm ²
Rated impulse withstand voltage / Pollution severity	
Gauge to IEC 60947-1 / UL 94 flammability rating	
Approvals	
Clamped conductors (H05V/H07V)	
Solid / Stranded	mm ²
Flexible / Flexible with ferrule	mm ²
Stripping length / Blade size	
Note	

DIN EN 60947-7-3

IEC	UL	CSA	EN 60079-7
500	150 (C)		
6.3	10		
4	AWG 26...10		
/ 3			
A4 / V-0			
Rated connection			
0.5...4 / 0.5...4			
0.5...4 / 0.5...4			
12 / 0.6 x 3.5 mm			
Note			

Arrangement	Applications			
	Only short-circuit protection		Overload	
	T _A max.	Nominal values	T _A max.	Nominal values
Individual	41 °C*	4,0 W / 6,3 A*	31 °C	1,6 W / 6,3 A
In combination	32 °C*	2,5 W / 6,3 A	34 °C	1,6 W / 6,3 A
Note				

Ordering data

Version	500 V AC/DC, without LED
Note	

Type	Qty.	Order No.
AFS 4 2C BK/BL	50	2548140000
Note		

Accessories

Pluggable cross-connection	2-pole 10-pole
End plate	Black
Test plug	
Terminal blocks identical in contour	
Screwdriver	Standard
Identification systems	
Note	

Type	current	Qty.	Order No.
ZQV 4N/2	32 A	60	1527930000
ZQV 4N/10	32 A	20	1528090000
AEP 3C 4 BK		20	2486640000
PS 2.0 MC		20	0310000000
A3C 4		50	2051240000
A3C 4 PE		50	2051410000
SDIL 0,6x3,5x100		1	9042110000
DEK 5/6 PLUS MC NE WS		1000	1011320000
WS 10/6 M PLUS MC NE WS		600	2003780000
DEK 5/6 MM WS		600	2007120000
WS 8/6 MM WS		600	2007160000
G 20/0.25A/F		10	0430500000
G 20/0.50A/F		10	0430600000
G 20/1.00A/F		10	0430700000
G 20/2.00A/F		10	0430900000
Note			

G-fuse cartridge, 5 x 20 mm (IEC 60127-2)	0.25 A fast 0.50 A fast 1.00 A fast 2.00 A fast
Note	

For detailed information on other accessories and application in the online catalogue

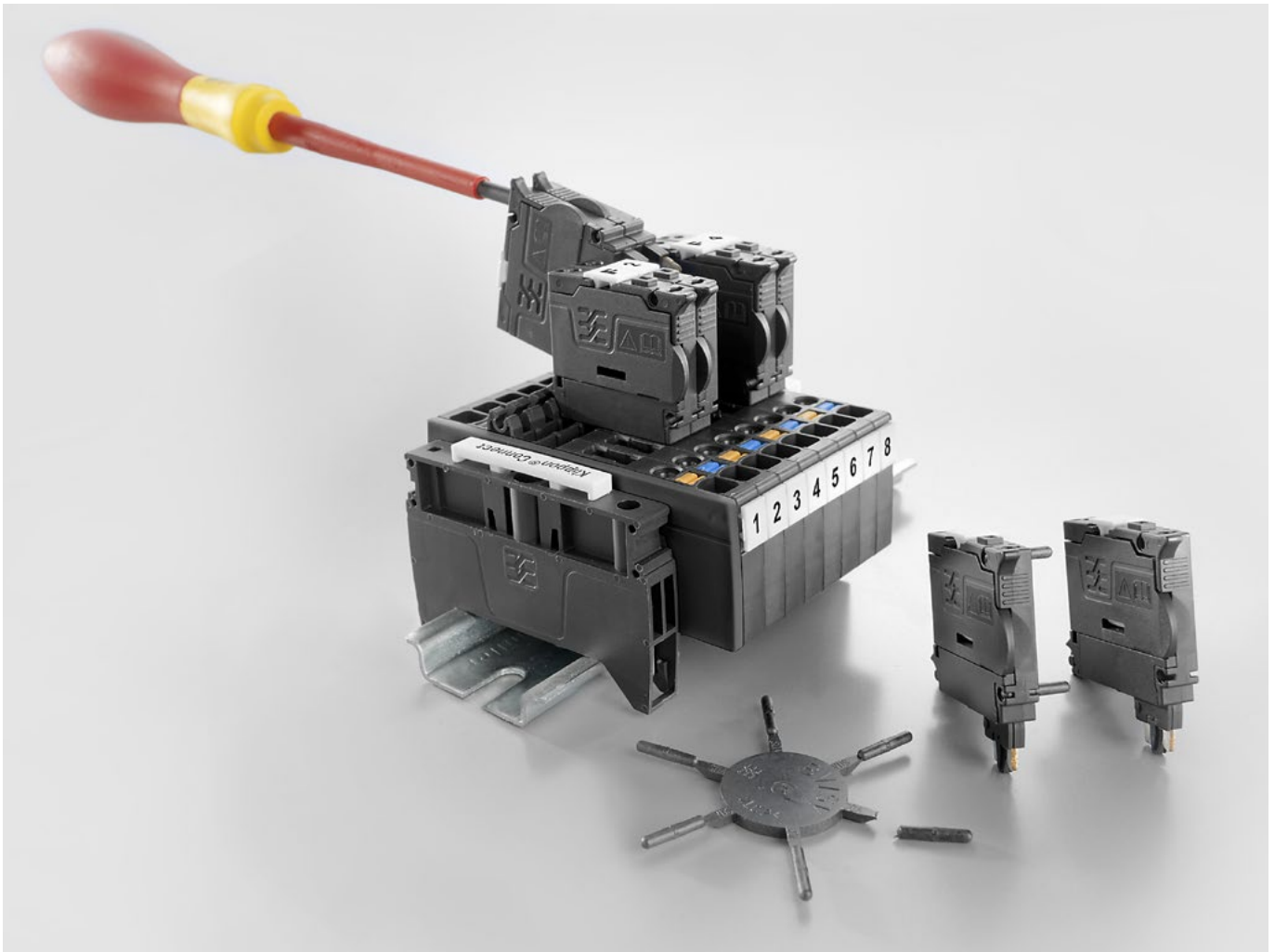

VDS180 SV7.62



Type	Qty.	Order No.
VDS180 SV7.62	50	1853940000

Spring connection with PUSH IN technology (A-Series)

Test-disconnect terminal blocks

Universal range

A



ADT 2.5 2C

2.5 mm²

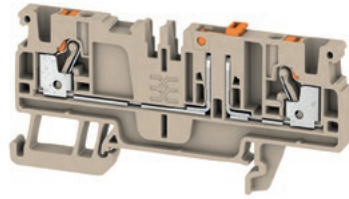

ADT 2.5 2C W/O DTLV

2.5 mm²

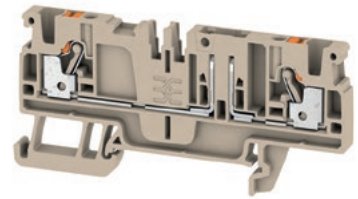

Width/Height/Depth	mm
max. current / max. cond. cross-section	A/mm ²
Max. clamping range	mm ²

5.1 x 77.5 x 37.65
20 / 2.5
0.14...2.5



5.1 x 77.5 x 36.5
20 / 2.5
0.14...2.5

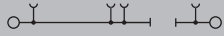

Technical data

Rated data	
Rated voltage of feed-through terminal	V
Rated current	A
for wire cross-section	mm ²
Rated impulse withstand voltage / Pollution severity	
Gauge to IEC 60947-1 / UL 94 flammability rating	
Number of operating cycles	
Approvals	
Clamped conductors (H05V/H07V)	
Solid / Stranded	mm ²
Flexible / Flexible with ferrule	mm ²
Stripping length / Blade size	mm/-
Note	

IEC 60947-7-1

IEC	UL	CSA	EN 60079-7
500	300	300	
20	20	20	
2.5	AWG 28...12	AWG 28...12	
6 kV / 3			
A3 / V-0			

CE

Rated connection	
0.5...2.5 / 0.5...2.5	
0.5...2.5 / 0.5...2.5	
10 / 0.6 x 3.5 mm	

Approval in progress

IEC 60947-7-1

IEC	UL	CSA	EN 60079-7
500	300	300	
20	20	20	
2.5	AWG 28...12	AWG 28...12	
6 kV / 3			
A3 / V-0			

CE

Rated connection	
0.5...2.5 / 0.5...2.5	
0.5...2.5 / 0.5...2.5	
10 / 0.6 x 3.5 mm	

Approval in progress

Ordering data

Version	
	dark beige
	blue
	without isolator
Note	

Type	Qty.	Order No.
ADT 2.5 2C	50	1989800000
ADT 2.5 2C BL	50	1989810000

Type	Qty.	Order No.
ADT 2.5 2C W/O DTLV	50	1989930000

Accessories

Pluggable cross-connection	
	2-pole
	10-pole
	2-pole
	10-pole
End plate	
	dark beige
	Blue
End bracket	
	dark beige
	dark beige
Test adapter	
	1-pole
	stackable
	3-pole
	5-pole
Test plug	
Screwdriver	
	Standard
Identification systems	

Type	current	Qty.	Order No.
ZQV 2.5N/2	24 A	60	1527540000
ZQV 2.5N/10	24 A	20	1527690000
End plate			
AEP 4C 2.5		50	1521530000
AEP 4C 2.5 BL		50	1521640000
End bracket			
AEB 35 SC/1		50	1991920000
ZEW 35		20	9540000000
Test adapter			
ATPG 1.5-10 L		50	1991890000
ATPG 2.5 MHR		50	1991960000
ATPG 2.5/3		25	2041190000
ATPG 2.5/5		25	2041180000
Test plug			
PS 2.0 MC		20	0310000000
Screwdriver			
SDIL 0,6x3,5x100		1	9042110000
Identification systems			
DEK 5/5 PLUS MC NE WS		1000	1854490000
DEK 5/5 MM WS		800	2007110000
WS 8/5 MM WS		800	2007150000
WS 10/5 M PLUS MC NE WS		600	2003770000

Type	current	Qty.	Order No.
ZQV 2.5N/2	24 A	60	1527540000
ZQV 2.5N/10	24 A	20	1527690000
End plate			
AEP 4C 2.5		50	1521530000
AEP 4C 2.5 BL		50	1521640000
End bracket			
AEB 35 SC/1		50	1991920000
ZEW 35		20	9540000000
Test adapter			
ATPG 1.5-10 L		50	1991890000
ATPG 2.5 MHR		50	1991960000
ATPG 2.5/3		25	2041190000
ATPG 2.5/5		25	2041180000
Test plug			
PS 2.0 MC		20	0310000000
Screwdriver			
SDIL 0,6x3,5x100		1	9042110000
Identification systems			
DEK 5/5 PLUS MC NE WS		1000	1854490000
DEK 5/5 MM WS		800	2007110000
WS 8/5 MM WS		800	2007150000
WS 10/5 M PLUS MC NE WS		600	2003770000

For detailed information on other accessories and application in the online catalogue

All MultiMark variants (MM) = strip markers

All MultiMark variants (MM) = strip markers

A2C 2.5 /DT/FS

2.5 mm²

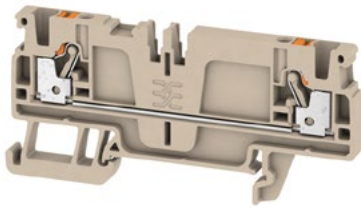

5.1 x 77.5 x 36.5
24 / 2.5
0.14...2.5



IEC 60947-7-1

IEC	UL	CSA	EN 60079-7
800	600	600	
24	20	20	
2.5	AWG 28...12	AWG 28...12	
8 kV / 3			
A3 / V-0			

CE

Rated connection

0.5...2.5 / 0.5...2.5

0.5...2.5 / 0.5...2.5

10 / 0.6 x 3.5 mm

Approval in progress

Type	Qty.	Order No.
A2C 2.5 /DT/FS	100	1989900000
A2C 2.5 /DT/FS BL	100	1989910000

Type	current	Qty.	Order No.
ZQV 2.5N/2	24 A	60	1527540000
ZQV 2.5N/10	24 A	20	1527690000
AEP 4C 2.5		50	1521530000
AEP 4C 2.5 BL		50	1521640000
AEB 35 SC/1		50	1991920000
ZEW 35		20	9540000000
ATPG 1.5-10 L		50	1991890000
ATPG 2.5 MI-R		50	1991960000
ATPG 2.5/3		25	2041190000
ATPG 2.5/5		25	2041180000
PS 2.0 MC		20	0310000000
SDIL 0,6x3,5x100		1	9042110000
DEK 5/5 PLUS MC NE WS		1000	1854490000
DEK 5/5 MM WS		800	2007110000
WS 8/5 MM WS		800	2007150000
WS 10/5 M PLUS MC NE WS		600	2003770000

All MultiMark variants (MM) = strip markers

A2C 2.5 PE /DT/FS

2.5 mm²

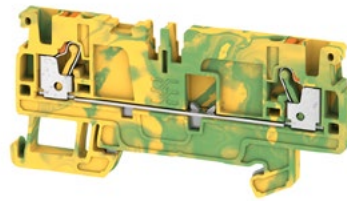

5.1 x 77.5 x 36.5
/ 2.5
0.14...2.5



IEC 60947-7-2

IEC	UL	CSA	EN 60079-7
	600	600	
2.5	AWG 28...12	AWG 28...12	
/ 3			
A3 / V-0			

CE

Rated connection

0.5...2.5 / 0.5...2.5

0.5...2.5 / 0.5...2.5

10 / 0.6 x 3.5 mm

Approval in progress

Type	Qty.	Order No.
A2C 2.5 PE /DT/FS	50	1989890000

Type	current	Qty.	Order No.
AEP 4C 2.5		50	1521530000
AEB 35 SC/1		50	1991920000
ZEW 35		20	9540000000
ATPG 1.5-10 L		50	1991890000
ATPG 2.5 MI-R		50	1991960000
ATPG 2.5/3		25	2041190000
ATPG 2.5/5		25	2041180000
PS 2.0 MC		20	0310000000
SDIL 0,6x3,5x100		1	9042110000
DEK 5/5 PLUS MC NE WS		1000	1854490000
DEK 5/5 MM WS		800	2007110000
WS 8/5 MM WS		800	2007150000
WS 10/5 M PLUS MC NE WS		600	2003770000

All MultiMark variants (MM) = strip markers

ADT 2.5 3C

2.5 mm²

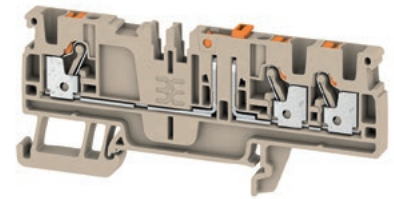

5.1 x 84.5 x 37.65
20 / 2.5
0.14...2.5

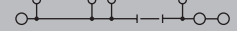

IEC 60947-7-1

IEC	UL	CSA	EN 60079-7
500	300	300	
20	20	20	
2.5	AWG 28...12	AWG 28...12	
6 kV / 3			
A3 / V-0			

CE

Rated connection

0.5...2.5 / 0.5...2.5

0.5...2.5 / 0.5...2.5

10 / 0.6 x 3.5 mm

Approval in progress

Type	Qty.	Order No.
ADT 2.5 3C	50	1989830000
ADT 2.5 3C BL	50	1989840000

Type	current	Qty.	Order No.
ZQV 2.5N/2	24 A	60	1527540000
ZQV 2.5N/10	24 A	20	1527690000
AEP DT 2.5 3C		50	1989970000
AEB 35 SC/1		50	1991920000
ZEW 35		20	9540000000
ATPG 1.5-10 L		50	1991890000
ATPG 2.5 MI-R		50	1991960000
ATPG 2.5/3		25	2041190000
ATPG 2.5/5		25	2041180000
PS 2.0 MC		20	0310000000
SDIL 0,6x3,5x100		1	9042110000
DEK 5/5 PLUS MC NE WS		1000	1854490000
DEK 5/5 MM WS		800	2007110000
WS 8/5 MM WS		800	2007150000
WS 10/5 M PLUS MC NE WS		600	2003770000

All MultiMark variants (MM) = strip markers



Spring connection with PUSH IN technology (A-Series)

Test-disconnect terminal blocks

Universal range

A



ADT 2.5 3C W/O DTLV

2.5 mm²

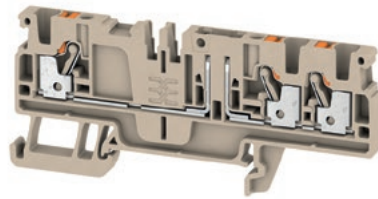

ADT 2.5 4C

2.5 mm²

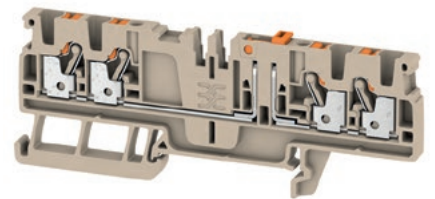

Width/Height/Depth	mm
max. current / max. cond. cross-section	A/mm ²
Max. clamping range	mm ²

5.1 x 84.5 x 36.5	
20 / 2.5	
0.14...2.5	

5.1 x 96 x 37.65	
20 / 2.5	
0.14...2.5	

Technical data

Rated data	
Rated voltage of feed-through terminal	V
Rated current	A
for wire cross-section	mm ²
Rated impulse withstand voltage / Pollution severity	
Gauge to IEC 60947-1 / UL 94 flammability rating	
Number of operating cycles	
Approvals	
Clamped conductors (H05V/H07V)	
Solid / Stranded	mm ²
Flexible / Flexible with ferrule	mm ²
Stripping length / Blade size	mm/-
Note	

IEC 60947-7-1

IEC	UL	CSA	EN 60079-7
500	300	300	
20	20	20	
2.5	AWG 28...12	AWG 28...12	
6 kV / 3			
A3 / V-0			

CE

Rated connection	
0.5...2.5 / 0.5...2.5	
0.5...2.5 / 0.5...2.5	
10 / 0.6 x 3.5 mm	

Approval in progress

IEC 60947-7-1

IEC	UL	CSA	EN 60079-7
500	300	300	
20	20	20	
2.5	AWG 28...12	AWG 28...12	
6 kV / 3			
A3 / V-0			

CE

Rated connection	
0.5...2.5 / 0.5...2.5	
0.5...2.5 / 0.5...2.5	
10 / 0.6 x 3.5 mm	

Approval in progress

Ordering data

Version	dark beige blue without isolator
Note	

Type	Qty.	Order No.
ADT 2.5 3C W/O DTLV	50	1989940000

Type	Qty.	Order No.
ADT 2.5 4C	50	1989860000
ADT 2.5 4C BL	50	1989870000

Accessories

Pluggable cross-connection	
2-pole	
10-pole	
2-pole	
10-pole	
End plate	
dark beige	
Blue	
End bracket	
dark beige	
dark beige	
Test adapter	
1-pole	
stackable	
3-pole	
5-pole	
Test plug	
Screwdriver	
Standard	
Identification systems	

Type	current	Qty.	Order No.
ZQV 2.5N/2	24 A	60	1527540000
ZQV 2.5N/10	24 A	20	1527690000
AEP DT 2.5 3C			
		50	1989970000
AEB 35 SC/1			
		50	1991920000
ZEW 35		20	9540000000
ATPG 1.5-10 L			
		50	1991890000
ATPG 2.5 MHR			
		50	1991960000
ATPG 2.5/3			
		25	2041190000
ATPG 2.5/5			
		25	2041180000
PS 2.0 MC			
		20	0310000000
SDIL 0,6x3,5x100			
		1	9042110000
DEK 5/5 PLUS MC NE WS		1000	1854490000
DEK 5/5 MM WS		800	2007110000
WS 8/5 MM WS		800	2007150000
WS 10/5 M PLUS MC NE WS		600	2003770000

Type	current	Qty.	Order No.
ZQV 2.5N/2	24 A	60	1527540000
ZQV 2.5N/10	24 A	20	1527690000
AEP DT 2.5 4C			
		50	1989980000
AEB 35 SC/1			
		50	1991920000
ZEW 35		20	9540000000
ATPG 1.5-10 L			
		50	1991890000
ATPG 2.5 MHR			
		50	1991960000
ATPG 2.5/3			
		25	2041190000
ATPG 2.5/5			
		25	2041180000
PS 2.0 MC			
		20	0310000000
SDIL 0,6x3,5x100			
		1	9042110000
DEK 5/5 PLUS MC NE WS		1000	1854490000
DEK 5/5 MM WS		800	2007110000
WS 8/5 MM WS		800	2007150000
WS 10/5 M PLUS MC NE WS		600	2003770000

For detailed information on other accessories and application in the online catalogue

All MultiMark variants (MM) = strip markers

All MultiMark variants (MM) = strip markers

ADT 2.5 4C W/O DTLV

2.5 mm²

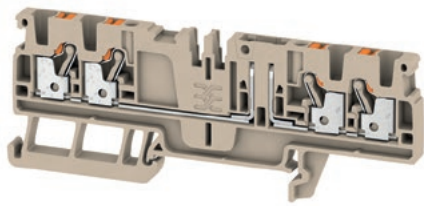

5.1 x 96 x 36.5
20 / 2.5
0.14...2.5



IEC 60947-7-1

IEC	UL	CSA	EN 60079-7
500	300	300	
20	20	20	
2.5	AWG 28...12	AWG 28...12	
6 kV / 3			
A3 / V-0			

CE

Rated connection

0.5...2.5 / 0.5...2.5

0.5...2.5 / 0.5...2.5

10 / 0.6 x 3.5 mm

Approval in progress

Type	Qty.	Order No.
ADT 2.5 4C W/O DTLV	50	1989950000

Type	current	Qty.	Order No.
ZQV 2.5N/2	24 A	60	1527540000
ZQV 2.5N/10	24 A	20	1527690000
AEP DT 2.5 4C		50	1989980000
AEB 35 SC/1		50	1991920000
ZEW 35		20	9540000000
ATPG 1.5-10 L		50	1991890000
ATPG 2.5 MI-R		50	1991960000
ATPG 2.5/3		25	2041190000
ATPG 2.5/5		25	2041180000
PS 2.0 MC		20	0310000000
SDIL 0,6x3,5x100		1	9042110000
DEK 5/5 PLUS MC NE WS		1000	1854490000
DEK 5/5 MM WS		800	2007110000
WS 8/5 MM WS		800	2007150000
WS 10/5 M PLUS MC NE WS		600	2003770000

All MultiMark variants (MM) = strip markers

ADT 4 2C

4 mm²

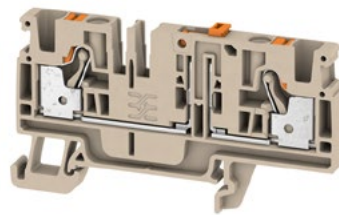

6.1 x 74 x 41
20 / 4
0.5...4



IEC/EN 60947-7-1:2009

IEC	UL	CSA	EN 60079-7
500	600		
24	20		
4	AWG 26...10		
4 kV / 3			
A4 / V-0			

Rated connection

0.5...4 / 0.5...4

0.5...4 / 0.5...4

10 / 0.6 x 3.5 mm

Approval in progress

Type	Qty.	Order No.
ADT 4 2C	50	2429850000
ADT 4 2C BL	50	2429880000

Type	current	Qty.	Order No.
ZQV 4N/2	32 A	60	1527930000
ZQV 4N/10	32 A	20	1528090000
AEP 4C 4		20	2051900000
AEP 4C 4 BL		20	2051910000
AEB 35 SC/1		50	1991920000
ZEW 35		20	9540000000
ATPG 1.5-10 L		50	1991890000
ATPG 4 M-R		50	1991860000
PS 2.0 MC		20	0310000000
SDIL 0,6x3,5x100		1	9042110000
WS 10/6 M PLUS MC NE WS		600	2003780000
DEK 5/6 MM WS		600	2007120000
WS 8/6 MM WS		600	2007160000
DEK 5/6 PLUS MC NE WS		1000	1011320000

All MultiMark variants (MM) = strip markers





Fast, flexible and efficient connection of functional units

Klippon® Connect modular pluggable terminal blocks

Modular and flexible connection techniques are in demand especially where entire functional units have to be prefabricated or replaced. Pluggable terminal blocks accelerate the assembly and simplify the exchange of functional units and the disassembly of parts for transport.

Klippon® Connect pluggable terminal blocks with PUSH IN connection technology combine the advantages of our unique connection technology with the flexibility of our connectors. They enable the quick and easy exchange of functional units in the control cabinet. The system works reliably even under the harshest conditions, and it is therefore also suitable for railway and ship applications.

Vibration resistance

All plugs can be connected safely and simply with the base terminal via the locking element. This protects your wiring from inadvertent disconnection of the connector.

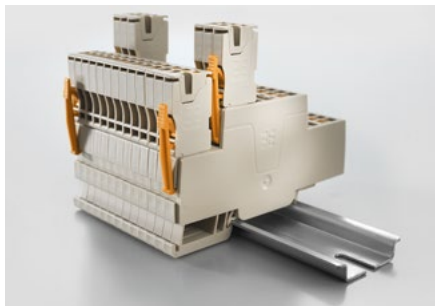

Protection against mismatching

Through the use of coding pins, individual coding options ensure trouble-free APGLE plug-in connection.





Protection against mechanical loading

The strain relief protects the contact against mechanical stress and protects the connector against inadvertent release from the contact point.

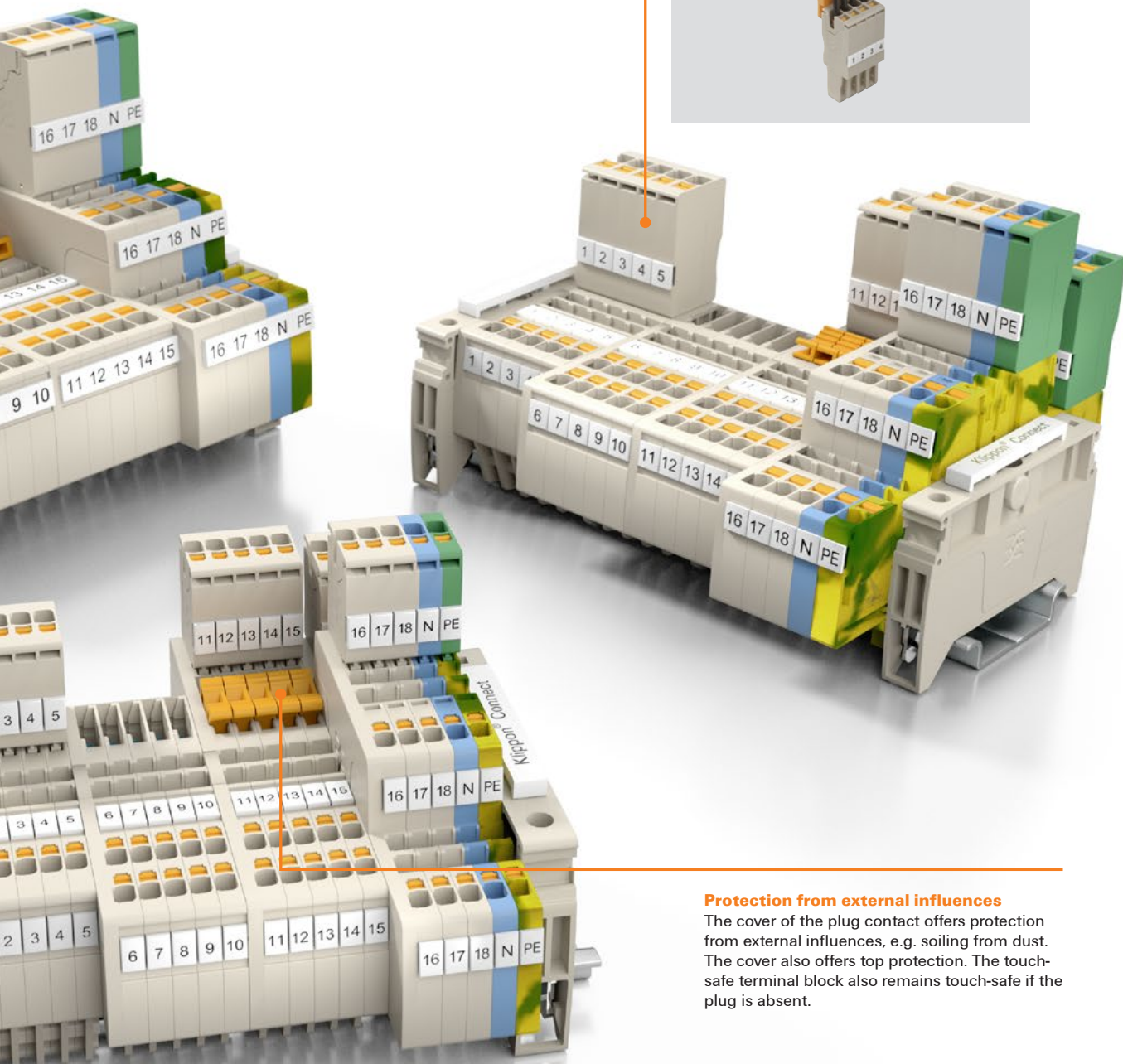

Protection from external influences

The cover of the plug contact offers protection from external influences, e.g. soiling from dust. The cover also offers top protection. The touch-safe terminal block also remains touch-safe if the plug is absent.

Spring connection with PUSH IN technology (A-Series)

Pluggable terminal blocks

Universal range

A



APGTB 1.5 FT 2C/1

1.5 mm²

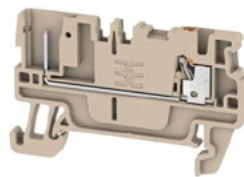

APGTB 1.5 PE 2C/1

1.5 mm²

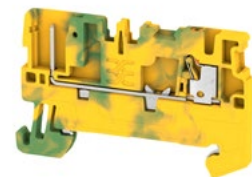

Width/Height/Depth	mm
max. current / max. cond. cross-section	-/mm ²
Max. clamping range	mm ²

3.5 x 55 x 33.5	
/ 1.5	
0.14...1.5	

3.5 x 55 x 33.5	
/ 1.5	
0.14...1.5	

Technical data

Rated data	
Rated voltage of feed-through terminal	V
Rated current	A
for wire cross-section	mm ²
Rated impulse withstand voltage / Pollution severity	
Gauge to IEC 60947-1 / UL 94 flammability rating	
Number of operating cycles	
Approvals	
Clamped conductors (H05V/H07V)	
Solid / Stranded	mm ²
Flexible / Flexible with ferrule	mm ²
Stripping length / Blade size	mm ² /-
Note	

IEC 60947-7-1, IEC 61984

IEC	UL	CSA	EN 60079-7
500			
17.5			
1.5			
	6 kV / 3		
	A1 / V-0		
Rated connection			
0.5...1.5 / 0.5...1.5			
0.5...1.5 / 0.5...1			
8 / 0.4 x 2.0 mm			
Approval in progress			

IEC 60947-7-2, IEC 61984

IEC	UL	CSA	EN 60079-7
500			
17.5			
1.5			
	6 kV / 3		
	A1 / V-0		
Rated connection			
0.5...1.5 / 0.5...1.5			
0.5...1.5 / 0.5...1			
8 / 0.4 x 2.0 mm			
Approval in progress			

Ordering data

Version	
	dark beige
	blue
	green/yellow
Note	

Type	Qty.	Order No.
APGTB 1.5 FT 2C/1	50	2482160000
APGTB 1.5 FT 2C/1 BL	50	2482170000
Note		

Type	Qty.	Order No.
APGTB 1.5 PE 2C/1	50	2482220000
Note		

Accessories

Pluggable cross-connection	
	2-pole
	10-pole
End plate	
	dark beige
	Blue
End bracket	
	dark beige
	dark beige
Plug	
Test plug	
Screwdriver	
	Standard
Identification systems	

Type	current	Qty.	Order No.
ZQV 1.5N/2	17.5 A	60	1985410000
ZQV 1.5N/10	17.5 A	20	1985580000
End plate			
AEP 2C 1.5		50	1552600000
AEP 2C 1.5 BL		50	1552610000
End bracket			
AEB 35 SC/1		50	1991920000
AEB 35 SCL/1 V0		20	2661280000
Plug			
APG 1.5/1		50	2482340000
APG 1.5/10		20	2482430000
APG 1.5 MI		50	2482280000
APG 1.5 L		50	2482250000
APG 1.5 R		50	2482310000
Test plug			
PS 2.0 MC		20	0310000000
Screwdriver			
SDS 0.4X2.0X60		1	9037160000
Identification systems			
WS 10/3.5 PLUS MC NE WS		960	2003760000
DEK 5/3.5 MM WS		1000	2007100000
WS 8/3.5 MM WS		1000	2007140000
DEK 5/3.5 PLUS MC NE WS		1600	2003750000

Type	current	Qty.	Order No.
ZQV 1.5N/2	17.5 A	60	1985410000
ZQV 1.5N/10	17.5 A	20	1985580000
End plate			
AEP 2C 1.5		50	1552600000
End bracket			
AEB 35 SC/1		50	1991920000
AEB 35 SCL/1 V0		20	2661280000
Plug			
APG 1.5/1		50	2482340000
APG 1.5/10		20	2482430000
APG 1.5 MI		50	2482280000
APG 1.5 L		50	2482250000
APG 1.5 R		50	2482310000
Test plug			
PS 2.0 MC		20	0310000000
Screwdriver			
SDS 0.4X2.0X60		1	9037160000
Identification systems			
WS 10/3.5 PLUS MC NE WS		960	2003760000
DEK 5/3.5 MM WS		1000	2007100000
WS 8/3.5 MM WS		1000	2007140000
DEK 5/3.5 PLUS MC NE WS		1600	2003750000

For detailed information on other accessories and application in the online catalogue

All MultiMark variants (MM) = strip markers

All MultiMark variants (MM) = strip markers

APGTB 1.5 FT 3C/1

1.5 mm²

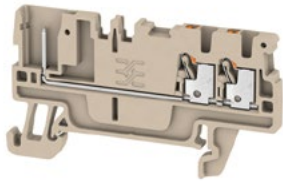

3.5 x 62 x 33.5
/ 1.5
0.14...1.5



IEC 60947-7-1, IEC 61984

IEC	UL	CSA	EN 60079-7
500			
17.5			
1.5			
	6 kV / 3		
	A1 / V-0		

Rated connection

0.5...1.5 / 0.5...1.5
0.5...1.5 / 0.5...1
8 / 0.4 x 2.0 mm

Approval in progress

Type	Qty.	Order No.
APGTB 1.5 FT 3C/1	50	2482180000
APGTB 1.5 FT 3C/1 BL	50	2482190000

Type	current	Qty.	Order No.
ZQV 1.5N/2	17.5 A	60	1985410000
ZQV 1.5N/10	17.5 A	20	1985580000
AEP 3C 1.5		50	1552620000
AEP 3C 1.5 BL		50	1552630000
AEB 35 SC/1		50	1991920000
AEB 35 SCL/1 VO		20	2661280000
APG 1.5/1		50	2482340000
APG 1.5/10		20	2482430000
APG 1.5 MI		50	2482280000
APG 1.5 L		50	2482250000
APG 1.5 R		50	2482310000
PS 2.0 MC		20	0310000000
SDS 0.4X2.0X60		1	9037160000
WS 10/3.5 PLUS MC NE WS		960	2003760000
DEK 5/3.5 MM WS		1000	2007100000
WS 8/3.5 MM WS		1000	2007140000
DEK 5/3.5 PLUS MC NE WS		1600	2003750000

All MultiMark variants (MM) = strip markers

APGTB 1.5 FT PE 3C/1

1.5 mm²

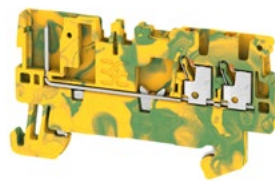

3.5 x 62 x 33.5
/ 1.5
0.14...1.5



IEC 60947-7-2, IEC 61984

IEC	UL	CSA	EN 60079-7
500			
17.5			
1.5			
	6 kV / 3		
	A1 / V-0		

Rated connection

0.5...1.5 / 0.5...1.5
0.5...1.5 / 0.5...1
8 / 0.4 x 2.0 mm

Approval in progress

Type	Qty.	Order No.
APGTB 1.5 PE 3C/1	50	2482230000

Type	current	Qty.	Order No.
ZQV 1.5N/2	17.5 A	60	1985410000
ZQV 1.5N/10	17.5 A	20	1985580000
AEP 3C 1.5		50	1552620000
AEB 35 SC/1		50	1991920000
AEB 35 SCL/1 VO		20	2661280000
APG 1.5/1		50	2482340000
APG 1.5/10		20	2482430000
APG 1.5 MI		50	2482280000
APG 1.5 L		50	2482250000
APG 1.5 R		50	2482310000
PS 2.0 MC		20	0310000000
SDS 0.4X2.0X60		1	9037160000
WS 10/3.5 PLUS MC NE WS		960	2003760000
DEK 5/3.5 MM WS		1000	2007100000
WS 8/3.5 MM WS		1000	2007140000
DEK 5/3.5 PLUS MC NE WS		1600	2003750000

All MultiMark variants (MM) = strip markers

APGTB 1.5 FT 4C/2

1.5 mm²



3.5 x 80 x 33.5
/ 1.5
0.14...1.5



IEC 60947-7-1, IEC 61984

IEC	UL	CSA	EN 60079-7
500			
17.5			
1.5			
	6 kV / 3		
	A1 / V-0		

Rated connection

0.5...1.5 / 0.5...1.5
0.5...1.5 / 0.5...1
8 / 0.4 x 2.0 mm

Approval in progress

Type	Qty.	Order No.
APGTB 1.5 FT 4C/2	50	2482200000
APGTB 1.5 FT 4C/2 BL	50	2482210000

Type	current	Qty.	Order No.
ZQV 1.5N/2	17.5 A	60	1985410000
ZQV 1.5N/10	17.5 A	20	1985580000
AEP PGTB 1.5 4C/2		50	2482510000
AEP PGTB 1.5 4C/2 BL		50	2482520000
AEB 35 SC/1		50	1991920000
AEB 35 SCL/1 VO		20	2661280000
APG 1.5/1		50	2482340000
APG 1.5/10		20	2482430000
APG 1.5 MI		50	2482280000
APG 1.5 L		50	2482250000
APG 1.5 R		50	2482310000
PS 2.0 MC		20	0310000000
SDS 0.4X2.0X60		1	9037160000
WS 10/3.5 PLUS MC NE WS		960	2003760000
DEK 5/3.5 MM WS		1000	2007100000
WS 8/3.5 MM WS		1000	2007140000
DEK 5/3.5 PLUS MC NE WS		1600	2003750000

All MultiMark variants (MM) = strip markers



Spring connection with PUSH IN technology (A-Series)
Pluggable terminal blocks

Universal range

A



APGTB 1.5 PE 4C/2

1.5 mm²

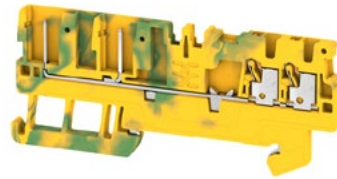

3.5 x 80 x 33.5
 / 1.5
 0.14...1.5



APGTB 1.5 2T 4C/2

1.5 mm²

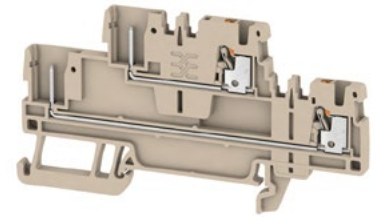

3.5 x 84.5 x 45
 / 1.5
 0.14...1.5

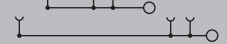

Width/Height/Depth	mm
max. current / max. cond. cross-section	-/mm ²
Max. clamping range	mm ²

Technical data

Rated data	
Rated voltage of feed-through terminal	V
Rated current	-
for wire cross-section	mm ²
Rated impulse withstand voltage / Pollution severity	
Gauge to IEC 60947-1 / UL 94 flammability rating	
Number of operating cycles	
Approvals	
Clamped conductors (H05V/H07V)	
Solid / Stranded	mm ²
Flexible / Flexible with ferrule	mm ²
Stripping length / Blade size	mm ² /-
Note	

Ordering data

Version	
	dark beige
	blue
	green/yellow
Note	

Accessories

Pluggable cross-connection	
	2-pole
	10-pole
End plate	
	dark beige
	Blue
End bracket	
	dark beige
	dark beige
Plug	
Test plug	
Screwdriver	
	Standard
Identification systems	

For detailed information on other accessories and application in the online catalogue

IEC 60947-7-2, IEC 61984

IEC	UL	CSA	EN 60079-7
500			
1.5		6 kV / 3	
		A1 / V-0	

Rated connection

0.5...1.5 / 0.5...1.5
0.5...1.5 / 0.5...1
8 / 0.4 x 2.0 mm
Approval in progress

Type	Qty.	Order No.
APGTB 1.5 PE 4C/2	50	2482240000

Type	current	Qty.	Order No.
ZQV 1.5N/2	17.5 A	60	1985410000
ZQV 1.5N/10	17.5 A	20	1985580000
AEP PGTB 1.5 4C/2		50	2482510000
AEB 35 SC/1		50	1991920000
AEB 35 SCL/1 V0		20	2661280000
APG 1.5/1		50	2482340000
APG 1.5/10		20	2482430000
APG 1.5 MI		50	2482280000
APG 1.5 L		50	2482250000
APG 1.5 R		50	2482310000
PS 2.0 MC		20	0310000000
SDS 0.4X2.0X60		1	9037160000
WS 10/3.5 PLUS MC NE WS		960	2003760000
DEK 5/3.5 MM WS		1000	2007100000
WS 8/3.5 MM WS		1000	2007140000
DEK 5/3.5 PLUS MC NE WS		1600	2003750000

All MultiMark variants (MM) = strip markers

IEC 60947-7-1, IEC 61984

IEC	UL	CSA	EN 60079-7
500			
17.5			
1.5		6 kV / 3	
		A1 / V-0	

Rated connection

0.5...1.5 / 0.5...1.5
0.5...1.5 / 0.5...1
8 / 0.4 x 2.0 mm
Approval in progress

Type	Qty.	Order No.
APGTB 1.5 2T 4C/2	50	2485840000
APGTB 1.5 2T 4C/2 BL	50	2485850000

Type	current	Qty.	Order No.
ZQV 1.5N/2	17.5 A	60	1985410000
ZQV 1.5N/10	17.5 A	20	1985580000
AEP 2T 1.5		20	2469420000
AEP 2T 1.5 BL		20	2471470000
AEB 35 SC/1		50	1991920000
AEB 35 SCL/1 V0		20	2661280000
APG 1.5/1		50	2482340000
APG 1.5/10		20	2482430000
APG 1.5 MI		50	2482280000
APG 1.5 L		50	2482250000
APG 1.5 R		50	2482310000
PS 2.0 MC		20	0310000000
SDS 0.4X2.0X60		1	9037160000
WS 10/3.5 PLUS MC NE WS		960	2003760000
DEK 5/3.5 MM WS		1000	2007100000
WS 8/3.5 MM WS		1000	2007140000
DEK 5/3.5 PLUS MC NE WS		1600	2003750000

All MultiMark variants (MM) = strip markers

APGTB 1.5 2T VL 4C/2

1.5 mm²

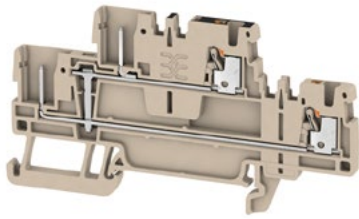

3.5 x 84.5 x 45
/ 1.5
0.14...1.5



IEC 60947-7-1, IEC 61984

IEC	UL	CSA	EN 60079-7
500			
17.5			
1.5			
6 kV / 3			
A1 / V-0			

Rated connection

0.5...1.5 / 0.5...1.5
0.5...1.5 / 0.5...1
8 / 0.4 x 2.0 mm

Approval in progress

Type	Qty.	Order No.
APGTB 1.5 2T VL 4C/2	50	2485920000
APGTB 1.5 2T VL 4C/2 BL	50	2485930000

Type	current	Qty.	Order No.
ZQV 1.5N/2	17.5 A	60	1985410000
ZQV 1.5N/10	17.5 A	20	1985580000
AEP 2T 1.5		20	2469420000
AEP 2T 1.5 BL		20	2471470000
AEB 35 SC/1		50	1991920000
AEB 35 SCL/1 VO		20	2661280000
APG 1.5/1		50	2482340000
APG 1.5/10		20	2482430000
APG 1.5 MI		50	2482280000
APG 1.5 L		50	2482250000
APG 1.5 R		50	2482310000
PS 2.0 MC		20	0310000000
SDS 0.4X2.0X60		1	9037160000
WS 10/3.5 PLUS MC NE WS		960	2003760000
DEK 5/3.5 MM WS		1000	2007100000
WS 8/3.5 MM WS		1000	2007140000
DEK 5/3.5 PLUS MC NE WS		1600	2003750000

All MultiMark variants (MM) = strip markers

APGTB 1.5 2T FT PE 4C/2

1.5 mm²

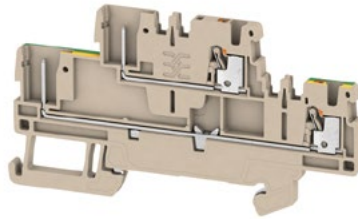

3.5 x 84.5 x 45
/ 1.5
0.14...1.5

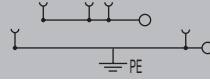

IEC 60947-7-1, IEC 61984, IEC 60947-7-2

IEC	UL	CSA	EN 60079-7
500			
17.5			
1.5			
6 kV / 3			
A1 / V-0			

Rated connection

0.5...1.5 / 0.5...1.5
0.5...1.5 / 0.5...1
8 / 0.4 x 2.0 mm

Approval in progress

Type	Qty.	Order No.
APGTB 1.5 2T FT-PE 4C/2	50	2485860000

Type	current	Qty.	Order No.
ZQV 1.5N/2	17.5 A	60	1985410000
ZQV 1.5N/10	17.5 A	20	1985580000
AEP 2T 1.5		20	2469420000
AEP 2T 1.5 BL		20	2471470000
AEB 35 SC/1		50	1991920000
AEB 35 SCL/1 VO		20	2661280000
APG 1.5/1		50	2482340000
APG 1.5/10		20	2482430000
APG 1.5 MI		50	2482280000
APG 1.5 L		50	2482250000
APG 1.5 R		50	2482310000
PS 2.0 MC		20	0310000000
SDS 0.4X2.0X60		1	9037160000
WS 10/3.5 PLUS MC NE WS		960	2003760000
DEK 5/3.5 MM WS		1000	2007100000
WS 8/3.5 MM WS		1000	2007140000
DEK 5/3.5 PLUS MC NE WS		1600	2003750000

All MultiMark variants (MM) = strip markers

APGTB 1.5 2T PE 4C/2

1.5 mm²

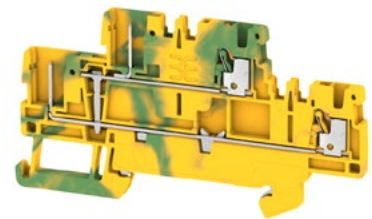

3.5 x 84.5 x 45
/ 1.5
0.14...1.5

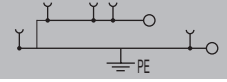

IEC 60947-7-2, IEC 61984

IEC	UL	CSA	EN 60079-7
500			
17.5			
1.5			
6 kV / 3			
A1 / V-0			

Rated connection

0.5...1.5 / 0.5...1.5
0.5...1.5 / 0.5...1
8 / 0.4 x 2.0 mm

Approval in progress

Type	Qty.	Order No.
APGTB 1.5 2T PE 4C/2	50	2485870000

Type	current	Qty.	Order No.
ZQV 1.5N/2	17.5 A	60	1985410000
ZQV 1.5N/10	17.5 A	20	1985580000
AEP 2T 1.5		20	2469420000
AEB 35 SC/1		50	1991920000
AEB 35 SCL/1 VO		20	2661280000
APG 1.5/1		50	2482340000
APG 1.5/10		20	2482430000
APG 1.5 MI		50	2482280000
APG 1.5 L		50	2482250000
APG 1.5 R		50	2482310000
PS 2.0 MC		20	0310000000
SDS 0.4X2.0X60		1	9037160000
WS 10/3.5 PLUS MC NE WS		960	2003760000
DEK 5/3.5 MM WS		1000	2007100000
WS 8/3.5 MM WS		1000	2007140000
DEK 5/3.5 PLUS MC NE WS		1600	2003750000

All MultiMark variants (MM) = strip markers



Spring connection with PUSH IN technology (A-Series)
Pluggable terminal blocks

Universal range

A



APGTB 2.5 FT 2C/1

2.5 mm²

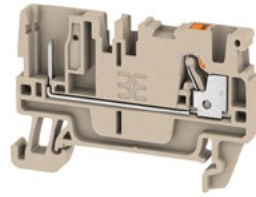

APGTB 2.5 PE 2C/1

2.5 mm²

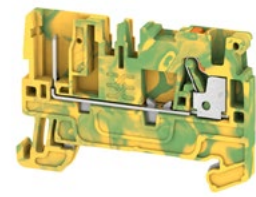

Width/Height/Depth	mm
max. current / max. cond. cross-section	A/mm ²
Max. clamping range	mm ²

5.1 x 55 x 36.5	
24 / 2.5	
0.14...2.5	

5.1 x 54 x 36.5	
/ 2.5	
0.14...2.5	

Technical data

Rated data	
Rated voltage of feed-through terminal	V
Rated current	A
for wire cross-section	mm ²
Rated impulse withstand voltage / Pollution severity	
Gauge to IEC 60947-1 / UL 94 flammability rating	
Number of operating cycles	
Approvals	
Clamped conductors (H05V/H07V)	
Solid / Stranded	mm ²
Flexible / Flexible with ferrule	mm ²
Stripping length / Blade size	mm/-
Note	

IEC 60947-7-1, IEC 61984

IEC	UL	CSA	EN 60079-7
800	600	600	
24	20	20	
2.5	AWG 28...12	AWG 28...12	
8 kV / 3			
A3 / V-0			

Rated connection	
0.5...2.5 / 0.5...2.5	
0.5...2.5 / 0.5...2.5	
10 / 0.6 x 3.5 mm	

Approval in progress

IEC 60947-7-2, IEC 61984

IEC	UL	CSA	EN 60079-7
800	600	600	
2.5	AWG 28...12	AWG 28...12	
/ 3			
A3 / V-0			

Rated connection	
0.5...2.5 / 0.5...2.5	
0.5...2.5 / 0.5...2.5	
10 / 0.6 x 3.5 mm	

Approval in progress

Ordering data

Version	
	dark beige
	blue
	green/yellow
Note	

Type	Qty.	Order No.
APGTB 2.5 FT 2C/1	100	1513970000
APGTB 2.5 FT 2C/1 BL	100	1513990000

Type	Qty.	Order No.
APGTB 2.5 PE 2C/1	50	1513870000

Accessories

Pluggable cross-connection	
	2-pole
	10-pole
End plate	
	dark beige
	Blue
End bracket	
	dark beige
	dark beige
Plug	
Test plug	
Screwdriver	
	Standard
Identification systems	

Type	current	Qty.	Order No.
ZQV 2.5N/2	24 A	60	1527540000
ZQV 2.5N/10	24 A	20	1527690000
AEP 2C 2.5			
AEP 2C 2.5		50	1514400000
AEP 2C 2.5 BL		50	1514420000
AEB 35 SC/1			
AEB 35 SC/1		50	1991920000
AEB 35 SCL/1 V0		20	2661280000
APG 2.5/1			
APG 2.5/1		50	1513720000
APG 2.5/10		20	1513770000
APG 2.5 MI		50	1513880000
APG 2.5 L		50	1513830000
APG 2.5 R		50	1513940000
PS 2.0 MC			
PS 2.0 MC		20	0310000000
SDIL 0,6x3,5x100			
SDIL 0,6x3,5x100		1	9042110000
DEK 5/5 PLUS MC NE WS			
DEK 5/5 PLUS MC NE WS		1000	1854490000
DEK 5/5 MM WS		800	2007110000
WS 8/5 MM WS		800	2007150000
WS 10/5 M PLUS MC NE WS		600	2003770000

All MultiMark variants (MM) = strip markers

Type	current	Qty.	Order No.
AEP 2C 2.5			
AEP 2C 2.5		50	1514400000
AEB 35 SC/1			
AEB 35 SC/1		50	1991920000
AEB 35 SCL/1 V0		20	2661280000
APG 2.5/1			
APG 2.5/1		50	1513720000
APG 2.5/10		20	1513770000
APG 2.5 MI		50	1513880000
APG 2.5 L		50	1513830000
APG 2.5 R		50	1513940000
PS 2.0 MC			
PS 2.0 MC		20	0310000000
SDIL 0,6x3,5x100			
SDIL 0,6x3,5x100		1	9042110000
DEK 5/5 PLUS MC NE WS			
DEK 5/5 PLUS MC NE WS		1000	1854490000
DEK 5/5 MM WS		800	2007110000
WS 8/5 MM WS		800	2007150000
WS 10/5 M PLUS MC NE WS		600	2003770000

All MultiMark variants (MM) = strip markers

For detailed information on other accessories and application in the online catalogue

APGTB 2.5 FT 3C/1

2.5 mm²

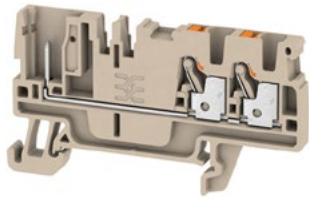

5.1 x 66.5 x 36.5
24 / 2.5
0.14...2.5



IEC 60947-7-1, IEC 61984

IEC	UL	CSA	EN 60079-7
800	600	600	
24	20	20	
2.5	AWG 28...12	AWG 28...12	
8 kV / 3			
A3 / V-0			



Rated connection

0.5...2.5 / 0.5...2.5
0.5...2.5 / 0.5...2.5
10 / 0.6 x 3.5 mm

Approval in progress

Type	Qty.	Order No.
APGTB 2.5 FT 3C/1	50	1514000000
APGTB 2.5 FT 3C/1 BL	50	1514020000

Type	current	Qty.	Order No.
ZQV 2.5N/2	24 A	60	1527540000
ZQV 2.5N/10	24 A	20	1527690000
AEP 3C 2.5		50	1521510000
AEP 3C 2.5 BL		50	1521520000
AEB 35 SC/1		50	1991920000
AEB 35 SCL/1 VO		20	2661280000
APG 2.5/1		50	1513720000
APG 2.5/10		20	1513770000
APG 2.5 MI		50	1513880000
APG 2.5 L		50	1513830000
APG 2.5 R		50	1513940000
SDIL 0,6x3,5x100		1	9042110000
DEK 5/5 PLUS MC NE WS		1000	1854490000
DEK 5/5 MM WS		800	2007110000
WS 8/5 MM WS		800	2007150000
WS 10/5 M MC NE WS		720	1792000000

All MultiMark variants (MM) = strip markers

APGTB 2.5 PE 3C/1

2.5 mm²

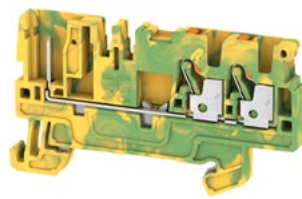

5.1 x 66.5 x 36.5
/ 2.5
0.14...2.5



IEC 60947-7-2, IEC 61984

IEC	UL	CSA	EN 60079-7
800	600	600	
2.5	AWG 28...12	AWG 28...12	
8 kV / 3			
A3 / V-0			



Rated connection

0.5...2.5 / 0.5...2.5
0.5...2.5 / 0.5...2.5
10 / 0.6 x 3.5 mm

Approval in progress

Type	Qty.	Order No.
APGTB 2.5 PE 3C/1	50	1513890000

Type	current	Qty.	Order No.
AEP 3C 2.5		50	1521510000
AEB 35 SC/1		50	1991920000
AEB 35 SCL/1 VO		20	2661280000
APG 2.5/1		50	1513720000
APG 2.5/10		20	1513770000
APG 2.5 MI		50	1513880000
APG 2.5 L		50	1513830000
APG 2.5 R		50	1513940000
SDIL 0,6x3,5x100		1	9042110000
DEK 5/5 PLUS MC NE WS		1000	1854490000
DEK 5/5 MM WS		800	2007110000
WS 8/5 MM WS		800	2007150000
WS 10/5 M MC NE WS		720	1792000000

All MultiMark variants (MM) = strip markers

APGTB 2.5 FT 4C/2

2.5 mm²

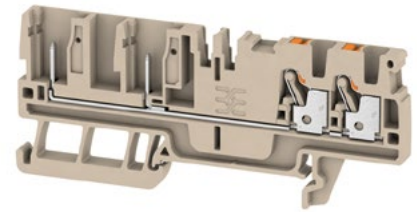

5.1 x 87 x 36.5
24 / 2.5
0.14...2.5



IEC 60947-7-1, IEC 61984

IEC	UL	CSA	EN 60079-7
800	600	600	
24	20	20	
2.5	AWG 28...12	AWG 28...12	
8 kV / 3			
A3 / V-0			



Rated connection

0.5...2.5 / 0.5...2.5
0.5...2.5 / 0.5...2.5
10 / 0.6 x 3.5 mm

Approval in progress

Type	Qty.	Order No.
APGTB 2.5 FT 4C/2	50	1514030000
APGTB 2.5 FT 4C/2 BL	50	1514040000

Type	current	Qty.	Order No.
ZQV 2.5N/2	24 A	60	1527540000
ZQV 2.5N/10	24 A	20	1527690000
AEP PGTB 2.5 4C/2		50	1514450000
AEP PGTB 2.5 4C/2 BL		50	1514470000
AEB 35 SC/1		50	1991920000
AEB 35 SCL/1 VO		20	2661280000
APG 2.5/1		50	1513720000
APG 2.5/10		20	1513770000
APG 2.5 MI		50	1513880000
APG 2.5 L		50	1513830000
APG 2.5 R		50	1513940000
SDIL 0,6x3,5x100		1	9042110000
DEK 5/5 PLUS MC NE WS		1000	1854490000
DEK 5/5 MM WS		800	2007110000
WS 8/5 MM WS		800	2007150000
WS 10/5 M MC NE WS		720	1792000000

All MultiMark variants (MM) = strip markers



Spring connection with PUSH IN technology (A-Series)
Pluggable terminal blocks

Universal range

A



APGTB 2.5 PE 4C/2

2.5 mm²

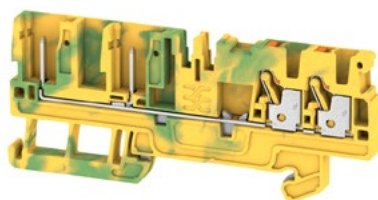

5.1 x 87 x 36.5
/ 2.5
0.14...2.5



APGTB 2.5 2T 4C/2

2.5 mm²

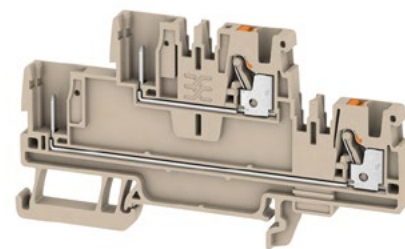

5.1 x 91 x 50.5
24 / 2.5
0.14...2.5

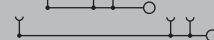

Width/Height/Depth	mm
max. current / max. cond. cross-section	-/mm ²
Max. clamping range	mm ²

Technical data

Rated data	
Rated voltage of feed-through terminal	V
Rated current	-
for wire cross-section	mm ²
Rated impulse withstand voltage / Pollution severity	
Gauge to IEC 60947-1 / UL 94 flammability rating	
Number of operating cycles	
Approvals	
Clamped conductors (H05V/H07V)	
Solid / Stranded	mm ²
Flexible / Flexible with ferrule	mm ²
Stripping length / Blade size	mm/-
Note	

Ordering data

Version	
	dark beige
	blue
	green/yellow
Note	

Accessories

Pluggable cross-connection	
	2-pole
	10-pole
End plate	
	dark beige
	Blue
End bracket	
	dark beige
	dark beige
Plug	
Test plug	
Screwdriver	Standard
Identification systems	

IEC 60947-7-2, IEC 61984

IEC	UL	CSA	EN 60079-7
800	600	600	
2.5	AWG 28...12	AWG 28...12	
	8 kV / 3		
	A3 / V-0		



Rated connection			
0.5...2.5 / 0.5...2.5			
0.5...2.5 / 0.5...2.5			
10 / 0.6 x 3.5 mm			
Approval in progress			

IEC 60947-7-1, IEC 61984

IEC	UL	CSA	EN 60079-7
800	600	600	
24	20	20	
2.5	AWG 28...12	AWG 28...12	
	8 kV / 3		
	A3 / V-0		



Rated connection			
0.5...2.5 / 0.5...2.5			
0.5...2.5 / 0.5...2.5			
10 / 0.6 x 3.5 mm			
Approval in progress			

Type	Qty.	Order No.
APGTB 2.5 PE 4C/2	50	1513920000

Type	current	Qty.	Order No.
AEP PGTB 2.5 4C/2		50	1514450000
AEB 35 SC/1		50	1991920000
AEB 35 SCL/1 V0		20	2661280000
APG 2.5/1		50	1513720000
APG 2.5/10		20	1513770000
APG 2.5 MI		50	1513880000
APG 2.5 L		50	1513830000
APG 2.5 R		50	1513940000
SDIL 0,6x3,5x100		1	9042110000
DEK 5/5 PLUS MC NE WS		1000	1854490000
DEK 5/5 MM WS		800	2007110000
WS 8/5 MM WS		800	2007150000
WS 10/5 M MC NE WS		720	1792000000

All MultiMark variants (MM) = strip markers

Type	Qty.	Order No.
APGTB 2.5 2T 4C/2	50	1548060000
APGTB 2.5 2T 4C/2 BL	50	1548070000

Type	current	Qty.	Order No.
ZQV 2.5N/2	24 A	60	1527540000
ZQV 2.5N/10	24 A	20	1527690000
AEP 2T 2.5		20	1547690000
AEP 2T 2.5 BL		20	1547700000
AEB 35 SC/1		50	1991920000
AEB 35 SCL/1 V0		20	2661280000
APG 2.5/1		50	1513720000
APG 2.5/10		20	1513770000
APG 2.5 MI		50	1513880000
APG 2.5 L		50	1513830000
APG 2.5 R		50	1513940000
PS 2.0 MC		20	0310000000
SDIL 0,6x3,5x100		1	9042110000
DEK 5/5 PLUS MC NE WS		1000	1854490000
DEK 5/5 MM WS		800	2007110000
WS 8/5 MM WS		800	2007150000
WS 10/5 M PLUS MC NE WS		600	2003770000

All MultiMark variants (MM) = strip markers

For detailed information on other accessories and application in the online catalogue

APGTB 2.5 2T VL 4C/2

2.5 mm²

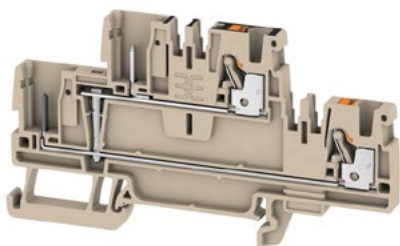

5.1 x 91 x 50.5
24 / 2.5
0.14...2.5



IEC 60947-7-1, IEC 61984

IEC	UL	CSA	EN 60079-7
800	600	600	
24	20	20	
2.5	AWG 28...12	AWG 28...12	
8 kV / 3			
A3 / V-0			



Rated connection

0.5...2.5 / 0.5...2.5
0.5...2.5 / 0.5...2.5
10 / 0.6 x 3.5 mm

Approval in progress

Type	Qty.	Order No.
APGTB 2.5 2T VL 4C/2	50	1548140000
APGTB 2.5 2T VL 4C/2 BL	50	1548150000

Type	current	Qty.	Order No.
ZQV 2.5N/2	24 A	60	1527540000
ZQV 2.5N/10	24 A	20	1527690000
AEP 2T 2.5		20	1547690000
AEP 2T 2.5 BL		20	1547700000
AEB 35 SC/1		50	1991920000
AEB 35 SCL/1 VO		20	2661280000
APG 2.5/1		50	1513720000
APG 2.5/10		20	1513770000
APG 2.5 MI		50	1513880000
APG 2.5 L		50	1513830000
APG 2.5 R		50	1513940000
PS 2.0 MC		20	0310000000
SDIL 0,6x3,5x100		1	9042110000
DEK 5/5 PLUS MC NE WS		1000	1854490000
DEK 5/5 MM WS		800	2007110000
WS 8/5 MM WS		800	2007150000
WS 10/5 M PLUS MC NE WS		600	2003770000

All MultiMark variants (MM) = strip markers

APGTB 2.5 2T FT-PE 4C/2

2.5 mm²

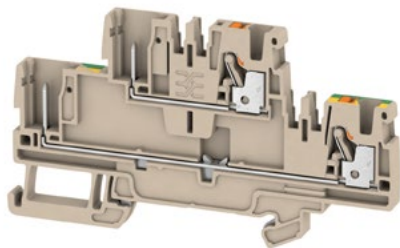

5.1 x 91 x 50.5
24 / 2.5
0.14...2.5

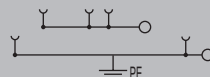

IEC 60947-7-1, IEC 60947-7-2, IEC 61984

IEC	UL	CSA	EN 60079-7
800	600		
24	20		
2.5	AWG 28...12		
8 kV / 3			
A3 / V-0			



Rated connection

0.5...2.5 / 0.5...2.5
0.5...2.5 / 0.5...2.5
10 / 0.6 x 3.5 mm

Approval in progress

Type	Qty.	Order No.
APGTB 2.5 2T FT-PE 4C/2	50	1548130000

Type	current	Qty.	Order No.
ZQV 2.5N/2	24 A	60	1527540000
ZQV 2.5N/10	24 A	20	1527690000
AEP 2T 2.5		20	1547690000
AEP 2T 2.5 BL		20	1547700000
AEB 35 SC/1		50	1991920000
AEB 35 SCL/1 VO		20	2661280000
APG 2.5/1		50	1513720000
APG 2.5/10		20	1513770000
APG 2.5 MI		50	1513880000
APG 2.5 L		50	1513830000
APG 2.5 R		50	1513940000
PS 2.0 MC		20	0310000000
SDIL 0,6x3,5x100		1	9042110000
DEK 5/5 PLUS MC NE WS		1000	1854490000
DEK 5/5 MM WS		800	2007110000
WS 8/5 MM WS		800	2007150000
WS 10/5 M PLUS MC NE WS		600	2003770000

All MultiMark variants (MM) = strip markers

APGTB 2.5 2T PE 4C/2

2.5 mm²

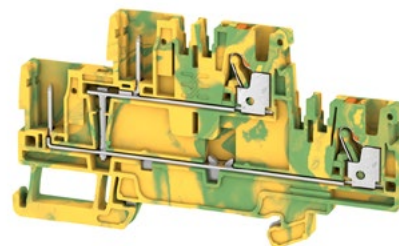

5.1 x 91 x 50.5
/ 2.5
0.14...2.5

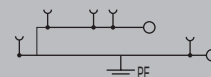

IEC 60947-7-2, IEC 61984

IEC	UL	CSA	EN 60079-7
800	600	600	
24	20	20	
2.5	AWG 28...12	AWG 28...12	
8 kV / 3			
A3 / V-0			



Rated connection

0.5...2.5 / 0.5...2.5
0.5...2.5 / 0.5...2.5
10 / 0.6 x 3.5 mm

Approval in progress

Type	Qty.	Order No.
APGTB 2.5 2T PE 4C/2	50	1548160000

Type	current	Qty.	Order No.
ZQV 2.5N/2	24 A	60	1527540000
ZQV 2.5N/10	24 A	20	1527690000
AEP 2T 2.5		20	1547690000
AEB 35 SC/1		50	1991920000
AEB 35 SCL/1 VO		20	2661280000
APG 2.5/10		20	1513770000
APG 2.5 MI		50	1513880000
APG 2.5 L		50	1513830000
APG 2.5 R		50	1513940000
PS 2.0 MC		20	0310000000
SDIL 0,6x3,5x100		1	9042110000
DEK 5/5 PLUS MC NE WS		1000	1854490000
DEK 5/5 MM WS		800	2007110000
WS 8/5 MM WS		800	2007150000
WS 10/5 M PLUS MC NE WS		600	2003770000

All MultiMark variants (MM) = strip markers



Spring connection with PUSH IN technology (A-Series)
Pluggable terminal blocks

Universal range

A



APGTB 4 FT 2C/1

4 mm²

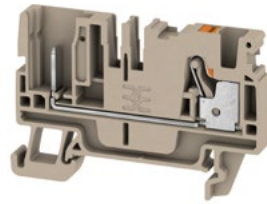

APGTB 4 PE 2C/1

4 mm²

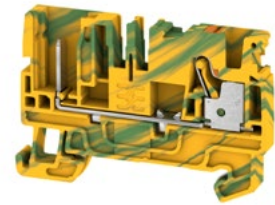

Width/Height/Depth	mm
max. current / max. cond. cross-section	-/mm ²
Max. clamping range	mm ²

6.1 x 59.5 x 39.5	
32 / 4	
0,14...4	

6.1 x 59.5 x 39.5	
/ 4	
0,14...4	

Technical data

Rated data	
Rated voltage of feed-through terminal	V
Rated current	-
for wire cross-section	mm ²
Rated impulse withstand voltage / Pollution severity	
Gauge to IEC 60947-1 / UL 94 flammability rating	
Number of operating cycles	
Approvals	
Clamped conductors (H05V/H07V)	
Solid / Stranded	mm ²
Flexible / Flexible with ferrule	mm ²
Stripping length / Blade size	mm/-
Note	

IEC 60947-7-1, IEC 61984			
IEC	UL	CSA	EN 60079-7
800			
32			
4			
		8 kV / 3	
		A4 / V-0	
CE			
Rated connection			
0.5...4 / 0.5...4			
0.5...4 / 0.5...4			
12 / 0.6 x 3.5 mm			
Approval in progress			

IEC 60947-7-2, IEC 61984			
IEC	UL	CSA	EN 60079-7
800			
4			
		8 kV / 3	
		A4 / V-0	
CE			
Rated connection			
0.5...4 / 0.5...4			
0.5...4 / 0.5...4			
12 / 0.6 x 3.5 mm			
Approval in progress			

Ordering data

Version	
	dark beige
	blue
	green/yellow
Note	

Type	Qty.	Order No.
APGTB 4 FT 2C/1	100	2540050000
APGTB 4 FT 2C/1 BL	100	2540060000

Type	Qty.	Order No.
APGTB 4 PE 2C/1	50	2540110000

Accessories

Pluggable cross-connection	
	2-pole
	10-pole
End plate	
	dark beige
	Blue
End bracket	
	dark beige
	dark beige
Plug	
Test plug	
Screwdriver	
	Standard
Identification systems	

Type	current	Qty.	Order No.
ZQV 4N/2	32 A	60	1527930000
ZQV 4N/10	32 A	20	1528090000
AEP 2C 4			
AEP 2C 4		50	2051680000
AEP 2C 4 BL		50	2051690000
AEB 35 SC/1			
AEB 35 SC/1		50	1991920000
AEB 35 SCL/1 V0		20	2661280000
APG 4/1			
APG 4/1		50	2540460000
APG 4/10		20	2540550000
APG 4 MI		50	2540580000
APG 4 L		50	2540360000
APG 4 R		50	2540610000
SDIL 0.6x3.5x100			
SDIL 0.6x3.5x100		1	9042110000
WS 10/6 M PLUS MC NE WS			
WS 10/6 M PLUS MC NE WS		600	2003780000
DEK 5/6 MM WS			
DEK 5/6 MM WS		600	2007120000
WS 8/6 MM WS			
WS 8/6 MM WS		600	2007160000
DEK 5/6 PLUS MC NE WS			
DEK 5/6 PLUS MC NE WS		1000	1011320000

Type	current	Qty.	Order No.
ZQV 4N/2	32 A	60	1527930000
ZQV 4N/10	32 A	20	1528090000
AEP 2C 4			
AEP 2C 4		50	2051680000
AEP 2C 4 BL		50	2051690000
AEB 35 SC/1			
AEB 35 SC/1		50	1991920000
AEB 35 SCL/1 V0		20	2661280000
APG 4/1			
APG 4/1		50	2540460000
APG 4/10		20	2540550000
APG 4 MI		50	2540580000
APG 4 L		50	2540360000
APG 4 R		50	2540610000
SDIL 0.6x3.5x100			
SDIL 0.6x3.5x100		1	9042110000
WS 10/6 M PLUS MC NE WS			
WS 10/6 M PLUS MC NE WS		600	2003780000
DEK 5/6 MM WS			
DEK 5/6 MM WS		600	2007120000
WS 8/6 MM WS			
WS 8/6 MM WS		600	2007160000
DEK 5/6 PLUS MC NE WS			
DEK 5/6 PLUS MC NE WS		1000	1011320000

For detailed information on other accessories and application in the online catalogue

All MultiMark variants (MM) = strip markers

All MultiMark variants (MM) = strip markers

APGTB 4 FT 3C/1

4 mm²

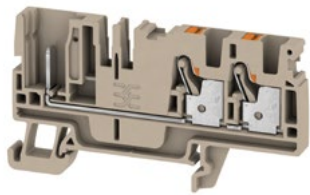

6.1 x 72 x 39.5
32 / 4
0,14...4

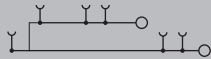

IEC 60947-7-1, IEC 61984

IEC	UL	CSA	EN 60079-7
800			
32			
4			
	8 kV / 3		
	A4 / V-0		

CE

Rated connection

0.5...4 / 0.5...4

0.5...4 / 0.5...4

12 / 0.6 x 3.5 mm

Approval in progress

Type	Qty.	Order No.
APGTB 4 FT 3C/1	50	2540070000
APGTB 4 FT 3C/1 BL	50	2540080000

Type	current	Qty.	Order No.
ZQV 4N/2	32 A	60	1527930000
ZQV 4N/10	32 A	20	1528090000
AEP 3C 4		20	2051720000
AEP 3C 4 BL		20	2051880000
AEB 35 SC/1		50	1991920000
AEB 35 SCL/1 VO		20	2661280000
APG 4/1		50	2540460000
APG 4/10		20	2540550000
APG 4 MI		50	2540580000
APG 4 L		50	2540360000
APG 4 R		50	2540610000
SDIL 0.6x3.5x100		1	9042110000
WS 10/6 M PLUS MC NE WS		600	2003780000
DEK 5/6 MM WS		600	2007120000
WS 8/6 MM WS		600	2007160000
DEK 5/6 PLUS MC NE WS		1000	1011320000

All MultiMark variants (MM) = strip markers

APGTB 4 PE 3C/1

4 mm²

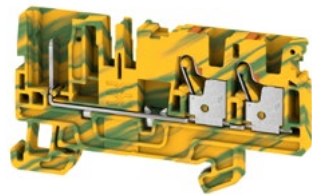

6.1 x 72 x 39.5
/ 4
0,14...4

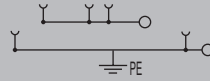

IEC 60947-7-2, IEC 61984

IEC	UL	CSA	EN 60079-7
800			
4			
	8 kV / 3		
	A4 / V-0		

CE

Rated connection

0.5...4 / 0.5...4

0.5...4 / 0.5...4

12 / 0.6 x 3.5 mm

Approval in progress

Type	Qty.	Order No.
APGTB 4 PE 3C/1	50	2540170000

Type	current	Qty.	Order No.
ZQV 4N/2	32 A	60	1527930000
ZQV 4N/10	32 A	20	1528090000
AEP 3C 4		20	2051720000
AEP 3C 4 BL		20	2051880000
AEB 35 SC/1		50	1991920000
AEB 35 SCL/1 VO		20	2661280000
APG 4/1		50	2540460000
APG 4/10		20	2540550000
APG 4 MI		50	2540580000
APG 4 L		50	2540360000
APG 4 R		50	2540610000
SDIL 0.6x3.5x100		1	9042110000
WS 10/6 M PLUS MC NE WS		600	2003780000
DEK 5/6 MM WS		600	2007120000
WS 8/6 MM WS		600	2007160000
DEK 5/6 PLUS MC NE WS		1000	1011320000

All MultiMark variants (MM) = strip markers

APGTB 4 FT 4C/2

4 mm²

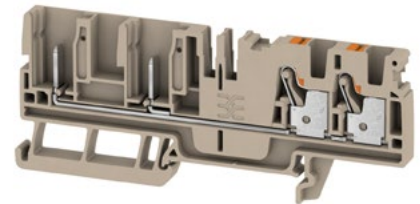

6.1 x 98 x 39.5
32 / 4
0,14...4

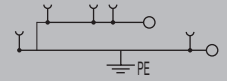

IEC 60947-7-1, IEC 61984

IEC	UL	CSA	EN 60079-7
800			
32			
4			
	8 kV / 3		
	A4 / V-0		

CE

Rated connection

0.5...4 / 0.5...4

0.5...4 / 0.5...4

12 / 0.6 x 3.5 mm

Approval in progress

Type	Qty.	Order No.
APGTB 4 FT 4C/2	50	2540090000
APGTB 4 FT 4C/2 BL	50	2540100000

Type	current	Qty.	Order No.
ZQV 4N/2	32 A	60	1527930000
ZQV 4N/10	32 A	20	1528090000
AEP PGTB 4 4C/2		20	2540210000
AEP PGTB 4 4C/2 BL		20	2540280000
AEB 35 SC/1		50	1991920000
AEB 35 SCL/1 VO		20	2661280000
APG 4/1		50	2540460000
APG 4/10		20	2540550000
APG 4 MI		50	2540580000
APG 4 L		50	2540360000
APG 4 R		50	2540610000
SDIL 0.6x3.5x100		1	9042110000
WS 10/6 M PLUS MC NE WS		600	2003780000
DEK 5/6 MM WS		600	2007120000
WS 8/6 MM WS		600	2007160000
DEK 5/6 PLUS MC NE WS		1000	1011320000

All MultiMark variants (MM) = strip markers



Spring connection with PUSH IN technology (A-Series) Pluggable terminal blocks

Universal range

A



APGTB 4 PE 4C/2

4 mm²

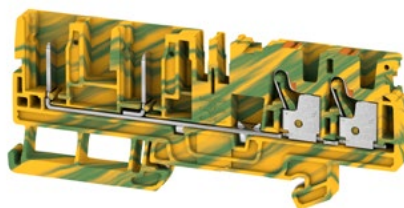

APGTB 4 2T 4C/2

4 mm²

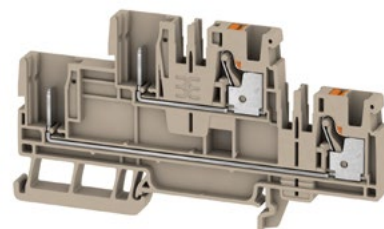

Width/Height/Depth	mm
max. current / max. cond. cross-section	-/mm ²
Max. clamping range	mm ²

6.1 x 98 x 39.5	
/ 4	
0,14...4	

6.1 x 100 x 53.5	
32 / 4	
0,14...4	

Technical data

Rated data	
Rated voltage of feed-through terminal	V
Rated current	-
for wire cross-section	mm ²
Rated impulse withstand voltage / Pollution severity	
Gauge to IEC 60947-1 / UL 94 flammability rating	
Number of operating cycles	
Approvals	
Clamped conductors (H05V/H07V)	
Solid / Stranded	mm ²
Flexible / Flexible with ferrule	mm ²
Stripping length / Blade size	mm/-

IEC 60947-7-2, IEC 61984

IEC	UL	CSA	EN 60079-7
800			
		8 kV / 3	
		A4 / V-0	

IEC 60947-7-1, IEC 61984

IEC	UL	CSA	EN 60079-7
800			
32			
4		8 kV / 3	
		A4 / V-0	

Note

CE

Rated connection	
0.5...4 / 0.5...4	
0.5...4 / 0.5...4	
12 / 0.6 x 3.5 mm	

CE

Rated connection	
0.5...4 / 0.5...4	
0.5...4 / 0.5...4	
12 / 0.6 x 3.5 mm	

Approval in progress

Approval in progress

Ordering data

Version	
	dark beige
	blue
	green/yellow

Type	Qty.	Order No.
APGTB 4 PE 4C/2	50	2540180000

Type	Qty.	Order No.
APGTB 4 2T 4C/2	50	2540230000
APGTB 4 2T 4C/2 BL	50	2540250000

Accessories

Pluggable cross-connection	
	2-pole
	10-pole

End plate	
	dark beige
	Blue

End bracket	
	dark beige
	dark beige

Plug	

Test plug	

Screwdriver	
	Standard

Identification systems	

Type	current	Qty.	Order No.
ZQV 4N/2	32 A	60	1527930000
ZQV 4N/10	32 A	20	1528090000

Type	Qty.	Order No.
AEP PGTB 4 4C/2	20	2540210000
AEP PGTB 4 4C/2 BL	20	2540280000

Type	Qty.	Order No.
AEB 35 SC/1	50	1991920000
AEB 35 SCL/1 V0	20	2661280000

Type	Qty.	Order No.
APG 4/1	50	2540460000
APG 4/10	20	2540550000
APG 4 MI	50	2540580000
APG 4 L	50	2540360000
APG 4 R	50	2540610000

SDIL 0.6x3.5x100	

Type	Qty.	Order No.
SDIL 0.6x3.5x100	1	9042110000

Type	Qty.	Order No.
WS 10/6 M PLUS MC NE WS	600	2003780000
DEK 5/6 MM WS	600	2007120000
WS 8/6 MM WS	600	2007160000
DEK 5/6 PLUS MC NE WS	1000	1011320000

Type	current	Qty.	Order No.
ZQV 4N/2	32 A	60	1527930000
ZQV 4N/10	32 A	20	1528090000

Type	Qty.	Order No.
AEP 2T 4	20	2540000000
AEP 2T 4 BL	20	2540010000

Type	Qty.	Order No.
AEB 35 SC/1	50	1991920000
AEB 35 SCL/1 V0	20	2661280000

Type	Qty.	Order No.
APG 4/1	50	2540460000
APG 4/10	20	2540550000
APG 4 MI	50	2540580000
APG 4 L	50	2540360000
APG 4 R	50	2540610000

SDIL 0.6x3.5x100	

Type	Qty.	Order No.
SDIL 0.6x3.5x100	1	9042110000

Type	Qty.	Order No.
WS 10/6 M PLUS MC NE WS	600	2003780000
DEK 5/6 MM WS	600	2007120000
WS 8/6 MM WS	600	2007160000
DEK 5/6 PLUS MC NE WS	1000	1011320000

For detailed information on other accessories and application in the online catalogue

All MultiMark variants (MM) = strip markers

All MultiMark variants (MM) = strip markers

APGTB 4 2T VL 4C/2

4 mm²

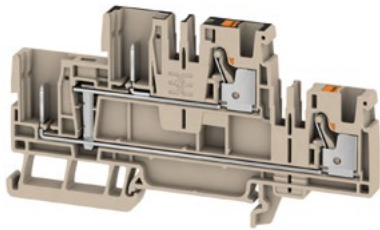

6.1 x 100 x 53.5
32 / 4
0,14...4



IEC 60947-7-1, IEC 61984

IEC	UL	CSA	EN 60079-7
800			
32			
4			
	8 kV / 3		
	A4 / V-0		

CE

Rated connection

0.5...4 / 0.5...4
0.5...4 / 0.5...4
12 / 0.6 x 3.5 mm

Approval in progress

Type	Qty.	Order No.
APGTB 4 2T VL 4C/2	50	2540260000
APGTB 4 2T VL 4C/2 BL	50	2540270000

Type	current	Qty.	Order No.
ZQV 4N/2	32 A	60	1527930000
ZQV 4N/10	32 A	20	1528090000
AEP 2T 4		20	2540000000
AEP 2T 4 BL		20	2540010000
AEB 35 SC/1		50	1991920000
AEB 35 SCL/1 VO		20	2661280000
APG 4/1		50	2540460000
APG 4/10		20	2540550000
APG 4 MI		50	2540580000
APG 4 L		50	2540360000
APG 4 R		50	2540610000
SDIL 0.6x3.5x100		1	9042110000
WS 10/6 M PLUS MC NE WS		600	2003780000
DEK 5/6 MM WS		600	2007120000
WS 8/6 MM WS		600	2007160000
DEK 5/6 PLUS MC NE WS		1000	1011320000

All MultiMark variants (MM) = strip markers

APGTB 4 2T FT-PE 4C/2

4 mm²

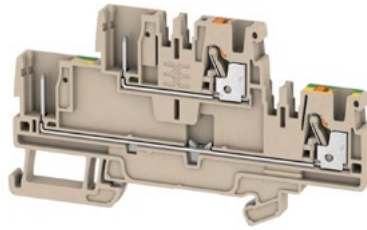

6.1 x 100 x 53.5
32 / 4
0,14...4

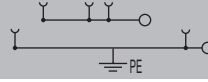

IEC 60947-7-1, IEC 60947-7-2, IEC 61984

IEC	UL	CSA	EN 60079-7
800			
32			
4			
	8 kV / 3		
	A4 / V-0		

CE

Rated connection

0.5...4 / 0.5...4
0.5...4 / 0.5...4
12 / 0.6 x 3.5 mm

Approval in progress

Type	Qty.	Order No.
APGTB 4 2T FT-PE 4C/2	50	2540290000

Type	current	Qty.	Order No.
ZQV 4N/2	32 A	60	1527930000
ZQV 4N/10	32 A	20	1528090000
AEP 2T 4		20	2540000000
AEP 2T 4 BL		20	2540010000
AEB 35 SC/1		50	1991920000
AEB 35 SCL/1 VO		20	2661280000
APG 4/1		50	2540460000
APG 4/10		20	2540550000
APG 4 MI		50	2540580000
APG 4 L		50	2540360000
APG 4 R		50	2540610000
SDIL 0.6x3.5x100		1	9042110000
WS 10/6 M PLUS MC NE WS		600	2003780000
DEK 5/6 MM WS		600	2007120000
WS 8/6 MM WS		600	2007160000
DEK 5/6 PLUS MC NE WS		1000	1011320000

All MultiMark variants (MM) = strip markers

APGTB 4 2T PE 4C/2

4 mm²

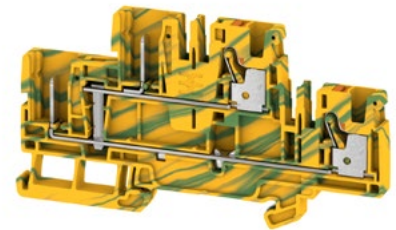

6.1 x 100 x 53.5
/ 4
0,14...4

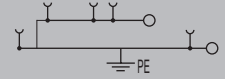

IEC 60947-7-2, IEC 61984

IEC	UL	CSA	EN 60079-7
800			
32			
4			
	8 kV / 3		
	A4 / V-0		

CE

Rated connection

0.5...4 / 0.5...4
0.5...4 / 0.5...4
12 / 0.6 x 3.5 mm

Approval in progress

Type	Qty.	Order No.
APGTB 2.5 2T PE 4C/2	50	1548160000

Type	current	Qty.	Order No.
ZQV 4N/2	32 A	60	1527930000
ZQV 4N/10	32 A	20	1528090000
AEP 2T 4		20	2540000000
AEP 2T 4 BL		20	2540010000
AEB 35 SC/1		50	1991920000
AEB 35 SCL/1 VO		20	2661280000
APG 4/1		50	2540460000
APG 4/10		20	2540550000
APG 4 MI		50	2540580000
APG 4 L		50	2540360000
APG 4 R		50	2540610000
SDIL 0.6x3.5x100		1	9042110000
WS 10/6 M PLUS MC NE WS		600	2003780000
DEK 5/6 MM WS		600	2007120000
WS 8/6 MM WS		600	2007160000
DEK 5/6 PLUS MC NE WS		1000	1011320000

All MultiMark variants (MM) = strip markers



Spring connection with PUSH IN technology (A-Series)
Pluggable terminal blocks

Universal range

A



APG 1.5...

1.5 mm²

APG 2.5...

2.5 mm²



Width/Height/Depth	mm
max. current / max. cond. cross-section	-/mm ²
Max. clamping range	mm ²

3.5 x 14 x 31.15
17,5/ 1,5
0.14...1.5

5.1 x 16.5 x 42.5
24 / 2,5
0.14...2.5

Technical data

Rated data	
Rated voltage	V
Rated current	A
for wire cross-section	mm ²
Rated impulse withstand voltage / Pollution severity	
Gauge to IEC 60947-1 / UL 94 flammability rating	
Approvals	
Clamped conductors (H05V/H07V)	
Solid / Stranded	-
Flexible / Flexible with ferrule	-
Stripping length / Blade size	mm/-
Note	

IEC	UL	CSA	EN 60079-7
500	300	600	
17.5	13	20	
1.5	AWG 26...14	AWG 26...14	
6 kW / 3			
A1 / V-0			
Rated connection		Plug-in connection	
0.5...1.5 / 0.5...1.5			
0.5...1.5 / 0.5...1.5			
8 / 0.4 x 2.0 mm			
Note			
Approval in progress			

IEC 61984			
IEC	UL	CSA	EN 60079-7
800	600	600	
24	20	20	
2.5	AWG 28...12	AWG 28...12	
8 kV / 3			
A3 / V-0			
Rated connection		Plug-in connection	
0.5...2.5 / 0.5...2.5			
0.5...2.5 / 0.5...2.5			
10 / 0.6 x 3.5 mm			
Note			
Approval in progress			

Ordering data

Version	Type	Qty.	Order No.
1-pole	APG 1.5/1	50	2482340000
	APG 1.5/2	25	2482350000
	APG 1.5/3	25	2482360000
	APG 1.5/4	25	2482370000
	APG 1.5/5	25	2482380000
	APG 1.5/6	25	2482390000
	APG 1.5/7	25	2482400000
	APG 1.5/8	20	2482410000
	APG 1.5/9	20	2482420000
	APG 1.5/10	20	2482430000
3-pole/BG-BL-GN	APG 1.5/3-BG-BL-GN	25	2482460000
	APG 1.5/4-3BG-GN	25	2482450000
	APG 1.5/5-3BG-BL-GN	25	2482440000
Note			

Type	Qty.	Order No.
APG 2.5/1	50	1513720000
APG 2.5/2	25	1513640000
APG 2.5/3	25	1513650000
APG 2.5/4	25	1513670000
APG 2.5/5	25	1513680000
APG 2.5/6	25	1513690000
APG 2.5/7	25	1513700000
APG 2.5/8	20	1513730000
APG 2.5/9	20	1513740000
APG 2.5/10	20	1513770000
APG 2.5/3-BG-BL-GN	25	1513820000
APG 2.5/4-3BG-GN	25	1513790000
APG 2.5/5-3BG-BL-GN	25	1513780000
Note		

Type	Qty.	Order No.
APG 2.5/1	50	1513720000
APG 2.5/2	25	1513640000
APG 2.5/3	25	1513650000
APG 2.5/4	25	1513670000
APG 2.5/5	25	1513680000
APG 2.5/6	25	1513690000
APG 2.5/7	25	1513700000
APG 2.5/8	20	1513730000
APG 2.5/9	20	1513740000
APG 2.5/10	20	1513770000
APG 2.5/3-BG-BL-GN	25	1513820000
APG 2.5/4-3BG-GN	25	1513790000
APG 2.5/5-3BG-BL-GN	25	1513780000
Note		

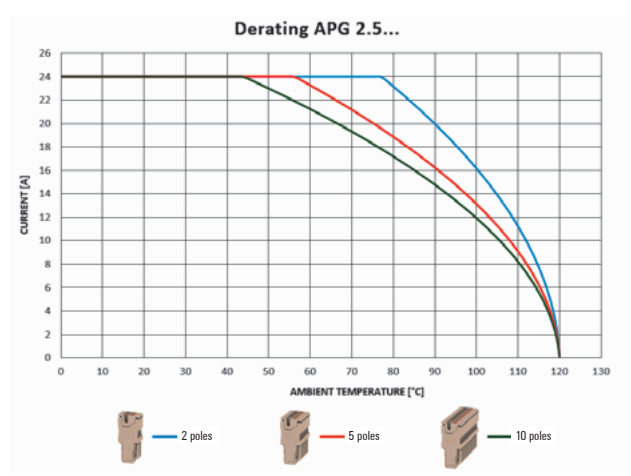
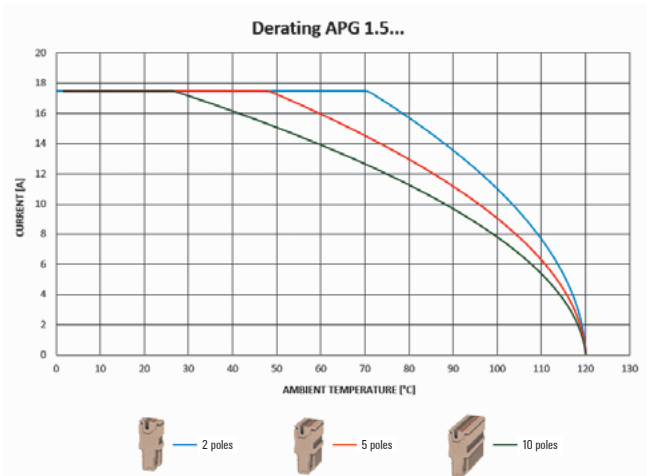

APG 4...

4 mm²



Width/Height/Depth	mm	6,1 x 19 x 50,95
max. current / max. cond. cross-section	-/mm ²	32/4
Max. clamping range	mm ²	0.14 mm ² - 4 mm ²

Technical data

Rated data	
Rated voltage	V
Rated current	A
for wire cross-section	mm ²
Rated impulse withstand voltage / Pollution severity	
Gauge to IEC 60947-1 / UL 94 flammability rating	
Approvals	
Clamped conductors (H05V/H07V)	
Solid / Stranded	-
Flexible / Flexible with ferrule	-
Stripping length / Blade size	mm/-
Note	

IEC	UL	CSA	EN 60079-7
690 V			
32 A			
4 mm ²			
		8 kV / 3	
		A 4 / V-0	
Rated connection		Plug-in connection	
0.5 ... 4 / 0.5 ... 4		0.5 ... 4 / 0.5 ... 4	
10 mm / 0.6 x 3.5 mm		10 mm / 0.6 x 3.5 mm	
Note			
Approval in progress			

Ordering data

Version	
1-pole	
2-pole	
3-pole	
4-pole	
5-pole	
6-pole	
7-pole	
8-pole	
9-pole	
10-pole	
3-pole/BG-BL-GN	
4-pole/3BG-GN	
5-pole/3BG-BL-GN	
Note	

Type	Qty.	Order No.
APG 4/1	50	2540460000
APG 4/2	25	2540470000
APG 4/3	25	2540480000
APG 4/4	25	2540490000
APG 4/5	25	2540500000
APG 4/6	25	2540510000
APG 4/7	25	2540520000
APG 4/8	20	2540530000
APG 4/9	20	2540540000
APG 4/10	20	2540550000
APG 4/3-BG-BL-GN	25	2540450000
APG 4/4-3BG-GN	25	2540440000
APG 4/5-3BG-BL-GN	25	2540430000
Note		

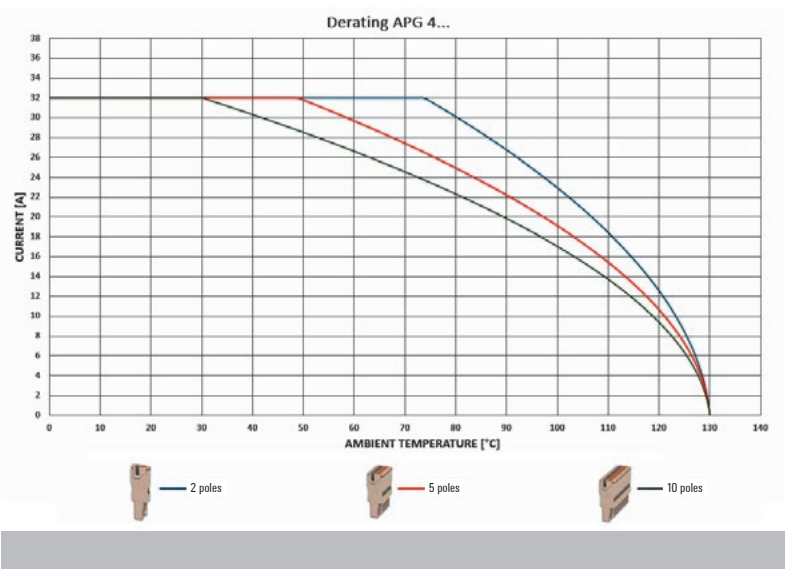



**Spring connection with PUSH IN technology (A-Series)
Pluggable terminal blocks**

Single plates for individual assembly

The individual plates increase flexibility by providing a solution for every task. The plug-in connector is assembled directly on-site in line with application requirements. Each individual plate is available in green (GN) and beige (BE).

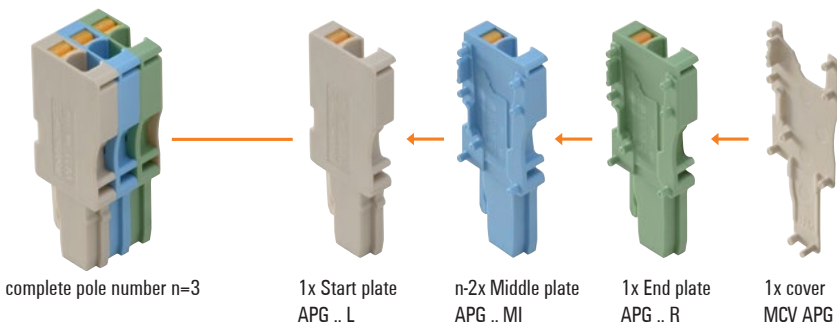

Plug

- Single plates, plug APG 1.5 L
- Marking option

APG 1.5

Start plate



APG 2.5

Middle plate or end plate



APG 4

Middle plate or end plate



Ordering data	
Single plates	
Start plate	
Middle plate	
End plate	
Cover	
Note	

Type	Qty.	Order No.
APG 1.5 L	50	2482250000
APG 1.5 L BL	50	2482260000
APG 1.5 L GN	50	2482270000
APG 1.5 MI	50	2482280000
APG 1.5 MI BL	50	2482290000
APG 1.5 MI GN	50	2482300000
APG 1.5 R	50	2482310000
APG 1.5 R BL	50	2482320000
APG 1.5 R GN	50	2482330000
MCV APG 1.5	50	2485980000

Type	Qty.	Order No.
APG 2.5 L	50	1513830000
APG 2.5 L BL	50	1513840000
APG 2.5 L GN	50	1513850000
APG 2.5 MI	50	1513880000
APG 2.5 MI BL	50	1513900000
APG 2.5 MI GN	50	1513930000
APG 2.5 R	50	1513940000
APG 2.5 R BL	50	1513950000
APG 2.5 R GN	50	1513980000
MCV APG 2.5	50	2035590000

Type	Qty.	Order No.
APG 4 L	50	2540360000
APG 4 L BL	50	2540560000
APG 4 L GN	50	2540570000
APG 4 MI	50	2540580000
APG 4 MI BL	50	2540590000
APG 4 MI GN	50	2540600000
APG 4 R	50	2540610000
APG 4 R BL	50	2540620000
APG 4 R GN	50	2540630000
MCV APG 4	50	2540800000

Strain relief

- Strain relief transmits mechanical forces to the plastic housing and protects the contact point

Ordering data	
	1.5 mm ²
	2.5 mm ² / 4 mm ²
Note	

APGSR

Strain reliefs



Type	Qty.	Order No.
APGSR 1.5	25	2482730000
APGSR 1.5/4	25	2482740000
APGSR 1.5/8	25	2482750000
APGSR 2.5	25	2457580000
APGSR 2.5/4	25	2457590000
APGSR 2.5/8	25	2457600000



Protective cover

- Finger protection Protects the contact point from dirt

Ordering data	
	1.5 mm ²
	2.5 mm ²
	4 mm ²
Note	

APGPC

Protective cover



Type	Qty.	Order No.
APGPC 1.5	50	2482530000
APGPC 2.5	50	1514500000
APGPC 4		2540960000

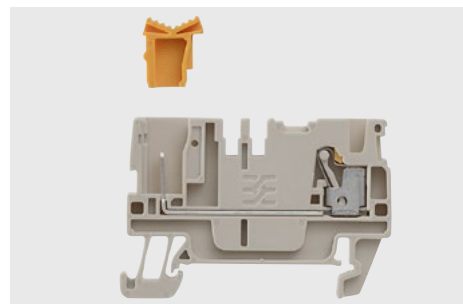

Coding elements

- For specific coding of the plug-in stations
- Protection against accidental mistake ensures process reliability

Ordering data	
	1.5 mm ² / 2.5 mm ² / 4 mm ²
Note	

APGCE

Coding elements

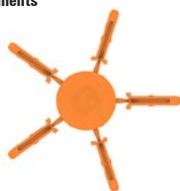

Type	Qty.	Order No.
APGCE	50	1514490000



Locking elements

- To interlock with the terminal block

Ordering data	
	1.5 mm ²
	2.5 mm ² / 4 mm ²
Note	

APGLE

Locking element



Type	Qty.	Order No.
APGLE 1.5	25	2482720000
APGLE 2.5/4	25	2457570000

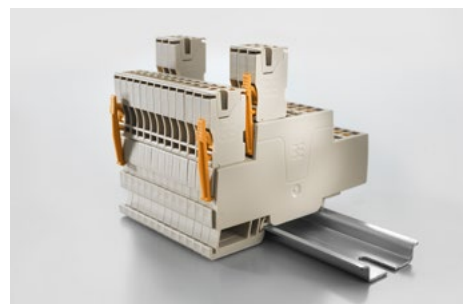

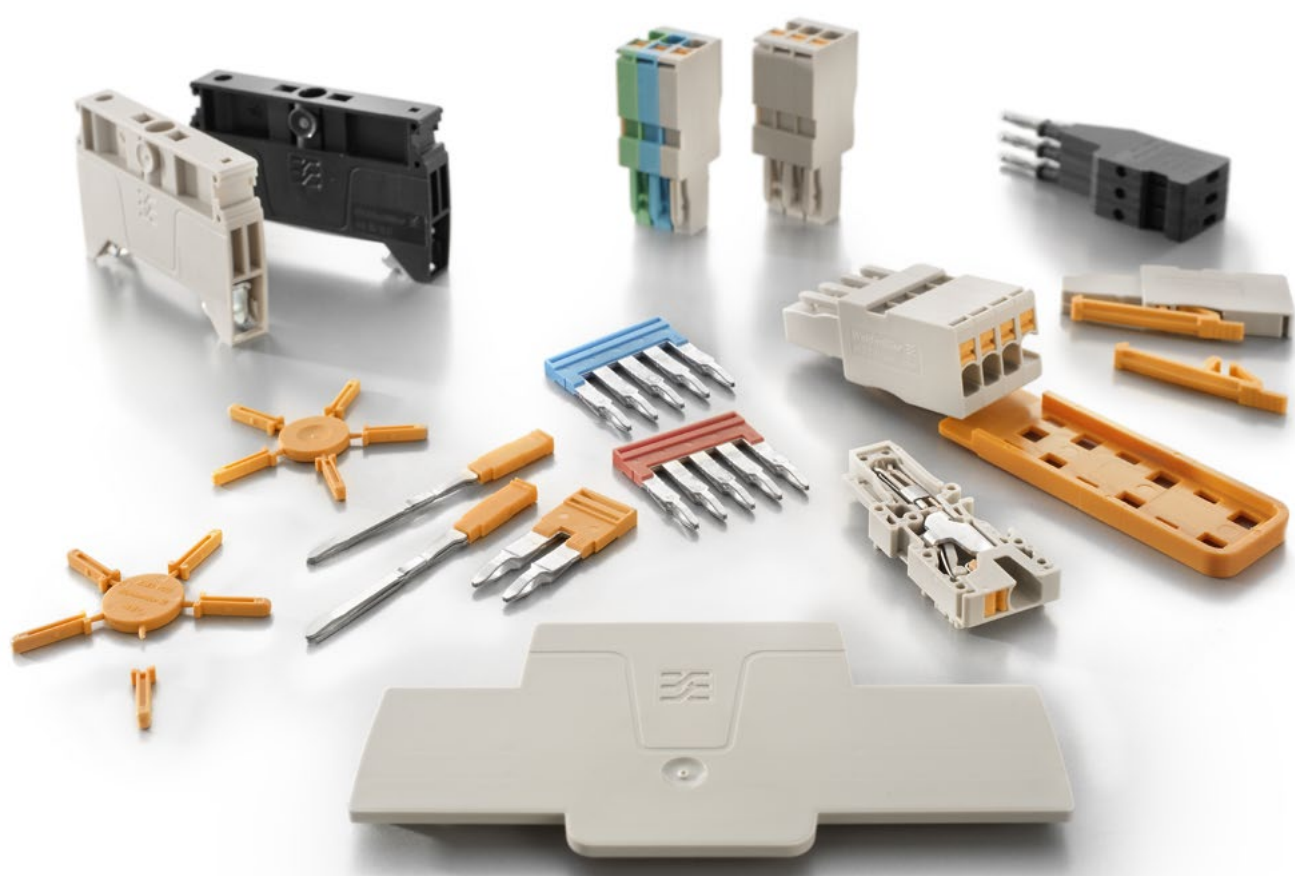

Integrated partition plate

APP1

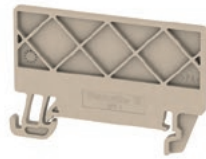

Dimensions	
Width / Height / Depth	mm
Continuous operating temp., min.	-60 °C
Continuous operating temp., max.	130 °C
Material	Wemid
UL 94 flammability rating	V-0

2.5 / 52.67 / 36.15
-60 °C
130 °C
Wemid
V-0

Ordering data	
	dark beige

Type	VPE	Best.-Nr.
APP 1	50	2488970000

matching terminals

A2C 1.5	1552790000
A2C 1.5 PE	1552680000
APGTB 1.5 FT 2C/1	2482160000
APGTB 1.5 PE 2C/1	2482220000
A2C 2.5	1521850000
A2C 2.5 PE	1521680000
APGTB 2.5 FT 2C/1	1513970000
APGTB 2.5 PE 2C/1	1513870000

Note

APP2



Dimensions	
Width / Height / Depth	mm
Continuous operating temp., min.	-60 °C
Continuous operating temp., max.	130 °C
Material	Wemid
UL 94 flammability rating	V-0

2.5 / 75.51 / 45.15
-60 °C
130 °C
Wemid
V-0

Type	Qty.	Order No.
APP 2	50	2489090000

Type	Qty.	Order No.
APP 3	50	2489100000

A3C 1.5	1552740000
A3C 1.5 PE	1552670000
A4C 1.5	1552690000
A4C 1.5 PE	1552660000
APGTB 1.5 FT 3C/1	2482180000
APGTB 1.5 PE 3C/1	2482230000
ADT 2.5 2C	1989800000
A2C 2.5 /DT/FS	1989900000
A2C 2.5 PE /DT/FS	1989890000
A3C 2.5	1521740000
A3C 2.5 PE	1521670000
A4C 2.5	1521690000
A4C 2.5 PE	1521540000
APGTB 2.5 FT 3C/1	1514000000
APGTB 2.5 PE 3C/1	1513890000
AFS 2.5 CF 2C BK	2466530000
AFS 2.5 CF 2C 12V BK	2466610000
AFS 2.5 CF 2C 24V BK	2466600000
A2C 4	2051180000
A2C 4 PE	2051360000
A3C 4	2051240000
A3C 4 PE	2051410000
A4C 4	2051500000
A4C 4 PE	2051560000
ADT 4 2C	2429850000
AFS 4 2C BK	2429860000
A2C 6	1992110000
A2C 6 PE	1991810000

APGTB 1.5 FT 4C/2	2482200000
APGTB 1.5 PE 4C/2	2482240000
APGTB 2.5 FT 4C/2	1514030000
APGTB 2.5 PE 4C/2	1513920000
ADT 2.5 3C	1989830000
ADT 2.5 4C	1989860000
A3C 6	1991820000
A3C 6 PE	1991850000
AAP11 ...	
AAP13 ...	
AI021 1.5 SI	1992260000
AI021 1.5 SO	1992240000
AI021 1.5 SO-PE	1992250000
AI022 1.5 SI-PE	1992230000

Integrated partition plate

APP4



Dimensions	
Width / Height / Depth	mm
Continuous operating temp., min.	-60 °C
Continuous operating temp., max.	130 °C
Material	Wemid
UL 94 flammability rating	V-0

2.5 / 89.15 / 54.85
-60 °C
130 °C
Wemid
V-0

Ordering data	
	dark beige

Type	Qty.	Order No.
APP 4	50	2489110000

matching terminals

APGTB 1.5 2T 4C/2	2485840000
APGTB 1.5 2T PE 4C/2	2485870000
A2T 1.5	2469370000
A2T 1.5 PE	2469410000
A2T 2.5	1547610000
A2T 2.5 PE	1547680000
APGTB 2.5 2T 4C/2	1548060000
APGTB 2.5 2T PE 4C/2	1548160000

Note



Pluggable Cross-Connection ZQV



Weidmüller offers plug-in and screwed cross-connection systems for screw-connection terminal blocks. The plug-in cross-connections feature easy handling and quick installation. This saves a great deal of time during installation in comparison with screwed solutions. This also ensures that all poles always contact reliably.

Fitting and changing crossconnections

The fitting and changing of cross-connections is a trouble-free and fast operation:

- Insert the cross-connection into the crossconnection channel in the terminal...

... and press it fully home.
(The cross-connection may not project from the channel.)

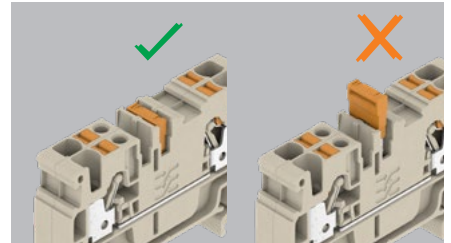
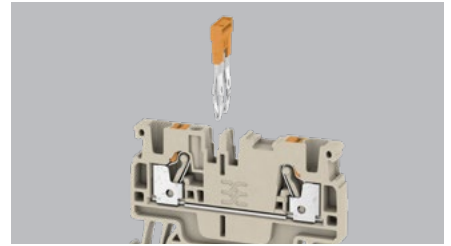

- Remove a cross-connection by simply prising it out with a screwdriver.

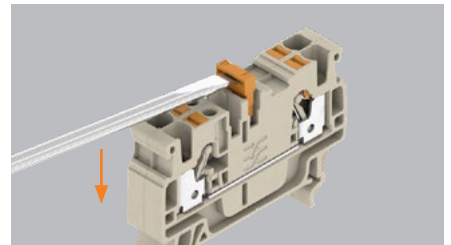

Shortening cross-connections

Cross-connections can be shortened in length using a suitable cutting tool, e.g. KT ZQV (order no. 9002170000). However, three contact elements must always be retained.

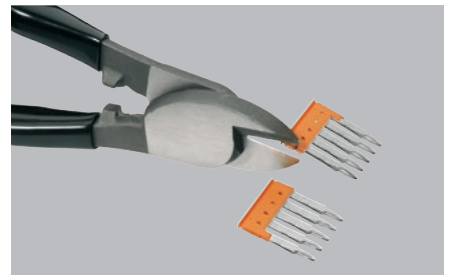

Breaking out contact elements

If one or more (max. 60 % for reasons of stability and temperature rise) of the contact elements are broken out of the cross-connections, terminals may be bypassed to suit the application.

Caution:

Contact elements must not be deformed!

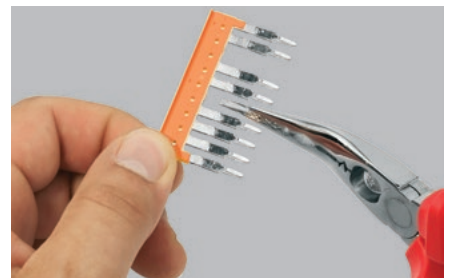

Note: By using manually cut ZQV and cross-connections with blank cut edges (> 10 poles) the voltage reduces to 25 V.

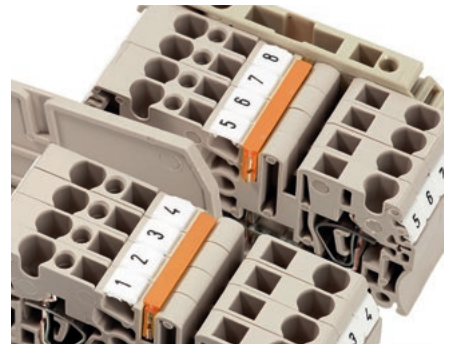

ALO 6 and ALO 16 supply terminals

The ALO 6 and ALO 16 supply terminals can be fed by wires of cross-section 6 or 16 mm². Over standard cross-connections the potential is distributed over any number of terminals blocks of smaller cross-section. Some variants for potential distribution during feed-in are indicated in the table below, including the cross-connection which can be used and the maximum current allowed.

Integrated into separation plate



Output options and cross-connectors to use

Supply terminal	Output terminal	Cross-connection	Feed-in left	Feed-in right
ALO 6	A2C 1.5	ZQV 1.5N	•	•
	A3C 1.5	ZQV 1.5N	•	•
	A4C 1.5	ZQV 1.5N	•	•
	A2C 2.5	ZQV 2.5N	•	•
	A3C 2.5	ZQV 2.5N	•	•
	A4C 2.5	ZQV 2.5N	•	•

Maximum current flow I_{max} only with ALO 6

Output terminal	Cross-connection	Wire cross-section Feed-in	Feed-in left or right	Feed-in centred
A2C 1.5	ZQV 1.5N	6 mm ²	41 A	41 A
A3C 1.5	ZQV 1.5N	6 mm ²	41 A	41 A
A4C 1.5	ZQV 1.5N	6 mm ²	41 A	41 A
A2C 2.5	ZQV 2.5N	6 mm ²	41 A	41 A
A3C 2.5	ZQV 2.5N	6 mm ²	41 A	41 A
A4C 2.5	ZQV 2.5N	6 mm ²	41 A	41 A

Output options and cross-connectors to use

Supply terminal	Output terminal	Cross-connection	Feed-in left	Feed-in right
ALO 16	A2C 1.5	ZQV 1.5N	•	•
	A3C 1.5	ZQV 1.5N	•	•
	A4C 1.5	ZQV 1.5N	•	•
	A2C 2.5	ZQV 2.5N	•	•
	A3C 2.5	ZQV 2.5N	•	•
	A4C 2.5	ZQV 2.5N	•	•
	A2C 4	ZQV 4N	•	•
	A3C 4	ZQV 4N	•	•
	A4C 4	ZQV 4N	•	•
	A2C 6	ZQV 6N	•	•
	A3C 6	ZQV 6N	•	•

Maximum current flow I_{max} only with ALO 16

Output terminal	Cross-connection	Wire cross-section Feed-in	Feed-in left or right	Feed-in centred
A2C 1.5	ZQV 1.5N	16 mm ²	48 A	72 A
A3C 1.5	ZQV 1.5N	16 mm ²	48 A	72 A
A4C 1.5	ZQV 1.5N	16 mm ²	48 A	72 A
A2C 2.5	ZQV 2.5N	16 mm ²	68 A	76 A
A3C 2.5	ZQV 2.5N	16 mm ²	68 A	76 A
A4C 2.5	ZQV 2.5N	16 mm ²	68 A	76 A
A2C 4	ZQV 4N	16 mm ²	76 A	76 A
A3C 4	ZQV 4N	16 mm ²	76 A	76 A
A4C 4	ZQV 4N	16 mm ²	76 A	76 A
A2C 6	ZQV 6N	16 mm ²	76 A	76 A
A3C 6	ZQV 6N	16 mm ²	76 A	76 A

Maximum current flow I_{max} only with ALO 16

Output terminal	Cross-connection	Wire cross-section Feed-in	Feed-in left or right	Feed-in centred
A2C 1.5	ZQV 1.5N	10 mm ²	40 A	40 A
A3C 1.5	ZQV 1.5N	10 mm ²	40 A	40 A
A4C 1.5	ZQV 1.5N	10 mm ²	40 A	40 A
A2C 2.5	ZQV 2.5N	10 mm ²	40 A	40 A
A3C 2.5	ZQV 2.5N	10 mm ²	40 A	40 A
A4C 2.5	ZQV 2.5N	10 mm ²	40 A	40 A
A2C 4	ZQV 4N	10 mm ²	40 A	40 A
A3C 4	ZQV 4N	10 mm ²	40 A	40 A
A4C 4	ZQV 4N	10 mm ²	40 A	40 A
A2C 6	ZQV 6N	10 mm ²	40 A	40 A
A3C 6	ZQV 6N	10 mm ²	40 A	40 A

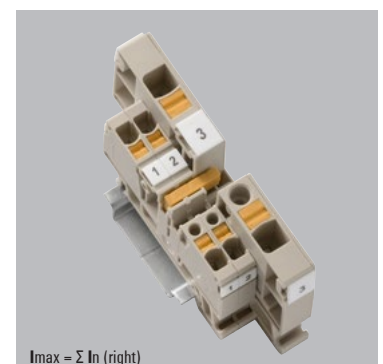
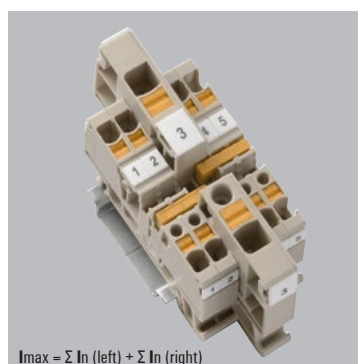
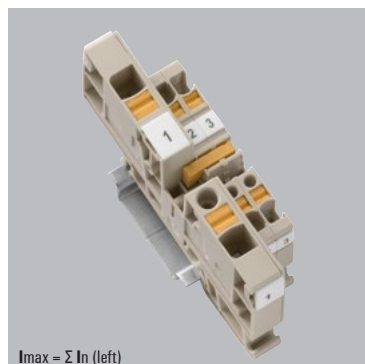

Supply with standard terminals

According to IEC 60204-1 and IEC 60 439-1, when reducing the conductors within distribution boards and controllers, protective devices for cables and conductors can be installed up to a maximum of 3 meters away from the supply side and need not be positioned at the beginning of the supply side. The conductor before the output fuse must be routed to make it "short-circuit proof".

Universal range

A

Supply on the right

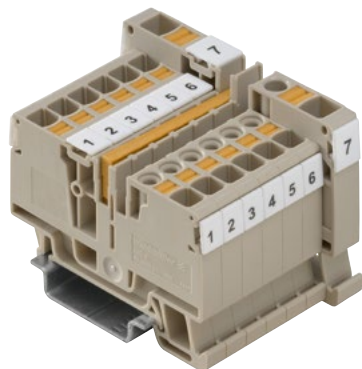

Supply on the left

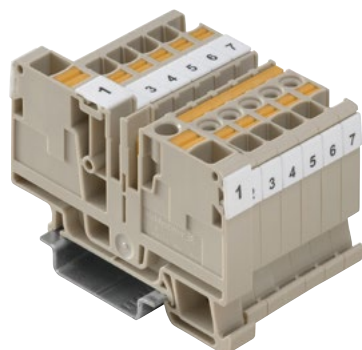

Supply options and corresponding cross-connections

Output terminals		right											
		2.5 mm ²					4 mm ²					6 mm ²	
Supply terminals		A2C	A3C	A4C	ADT 2C	AFS 2C CF	A2C	A3C	A4C	ADT 2C	AFS 2C	A2C	A3C
left													
1.5 mm ²	A2C	ZOV 1.5N	•										
	A3C		•										
	A4C		•										
2.5 mm ²	A2C	ZOV 2.5N					•	•					
	A3C						•	•					
	A4C												
	ADT 2C												
	AFS 2C CF												
4 mm ²	A2C	ZOV 4N										•	
	A3C											•	
	A4C											•	
	ADT 2C												
	AFS 2C												
left													
Output terminals		2.5 mm ²					4 mm ²					6 mm ²	
Supply terminals		A2C	A3C	A4C	ADT 2C	AFS 2C CF	A2C	A3C	A4C	ADT 2C	AFS 2C	A2C	A3C
1.5 mm ²	A2C	ZOV 1.5N	•	•	•	•	•	•	•	•	•		
	A3C			•	•	•	•	•	•	•	•		
	A4C			•	•	•	•	•	•	•	•		
2.5 mm ²	A2C	ZOV 2.5N					•	•	•	•	•	•	•
	A3C						•	•	•	•	•	•	•
	A4C							•	•	•	•	•	•
	ADT 2C								•	•	•	•	•
	AFS 2C CF									•	•	•	•
4 mm ²	A2C	ZOV 4N										•	•
	A3C											•	•
	A4C											•	•
	ADT 2C												
	AFS 2C												

Possible combinations

In one cross-connection channel

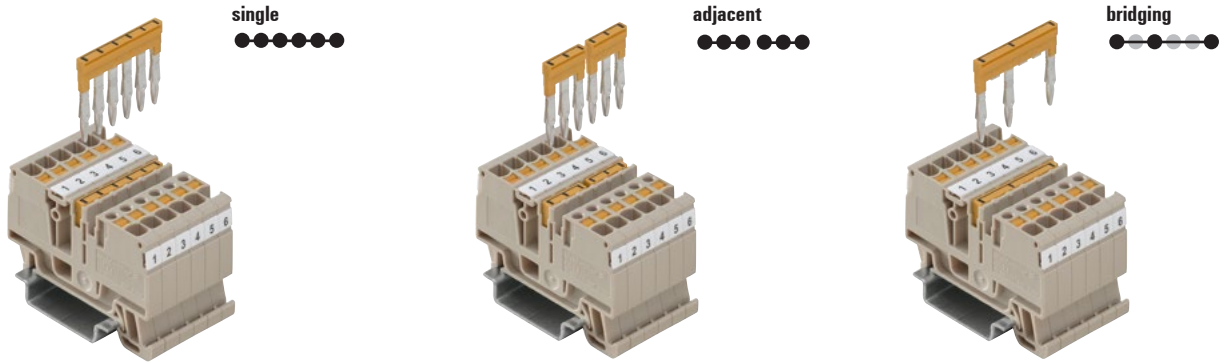

In two cross-connection channels

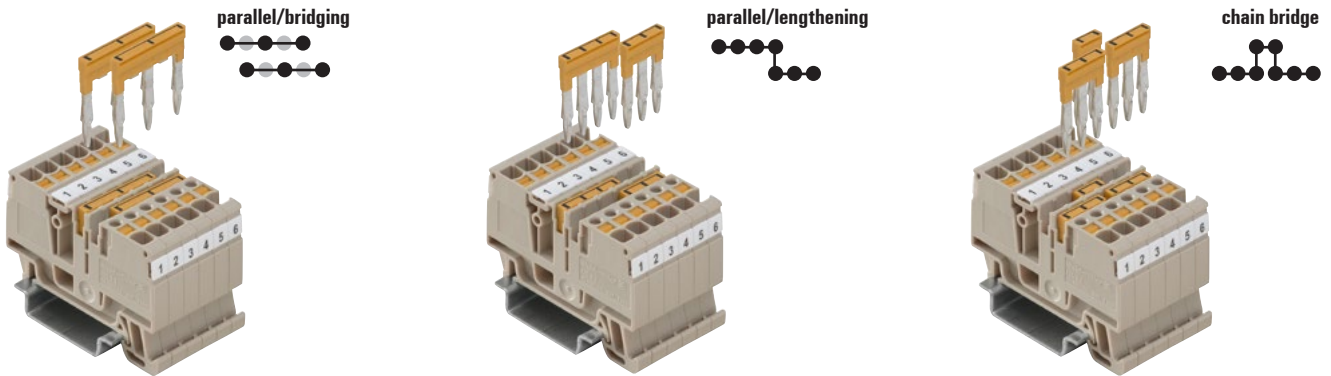

Possible cross-connections of terminals of the same type with corresponding cross-connections

Terminal type	Cross-section	Cross-connection	single	adjacent	bridging	chain bridge	parallel bridging	parallel lengthening
Standard terminals	mm ²							
A ... C	1.5	ZQV 1.5N/...	•	•	•	•	•	•
A2T	1.5	ZQV 1.5N/...	•	•	•	•	•	
A2T PE	1.5	ZQV 1.5N/...	•	•	•	•	•	
A3T	1.5	ZQV 1.5N/...	•	•	•	•	•	
A3T PE	1.5	ZQV 1.5N/...	•	•	•	•	•	
APGTB	1.5	ZQV 1.5N/...	•	•	•	•	•	
APGTB 2T	1.5	ZQV 1.5N/...	•	•	•	•	•	
APGTB 2T PE	1.5	ZQV 1.5N/...	•	•	•	•	•	
A ... C	2.5	ZQV 2.5N/...	•	•	•	•	•	
A2T	2.5	ZQV 2.5N/...	•	•	•	•	•	
A2T PE	2.5	ZQV 2.5N/...	•	•	•	•	•	
A3T	2.5	ZQV 2.5N/...	•	•	•	•	•	
A3T PE	2.5	ZQV 2.5N/...	•	•	•	•	•	
ADT	2.5	ZQV 2.5N/...	•	•	•	•	•	
AFS	2.5	ZQV 2.5N/...	•	•	•	•	•	
APGTB	2.5	ZQV 2.5N/...	•	•	•	•	•	
APGTB 2T	2.5	ZQV 2.5N/...	•	•	•	•	•	
APGTB 2T PE	2.5	ZQV 2.5N/...	•	•	•	•	•	
A ... C	4	ZQV 4N/...	•	•	•	•	•	
A2T	4	ZQV 4N/...	•	•	•	•	•	
A2T PE	4	ZQV 4N/...	•	•	•	•	•	
ADT	4	ZQV 4N/...	•	•	•	•	•	
AFS	4	ZQV 4N/...	•	•	•	•	•	
APGTB	4	ZQV 4N/...	•	•	•	•	•	
APGTB 2T	4	ZQV 4N/...	•	•	•	•	•	
APGTB 2T PE	4	ZQV 4N/...	•	•	•	•	•	
A ... C	6	ZQV 6N/...	•	•	•	•	•	
A ... C	10	ZQV 10N/...	•	•	•	•	•	
A ... C	16	ZQV 16N/...	•	•	•	•	•	

Cross-connections according to dimensions

Universal range

A



ZQV 1.5N



Technical data	
current	A
Ordering data	
2-pin	
3-pin	
4-pin	
5-pin	
6-pin	
7-pin	
8-pin	
9-pin	
10-pin	
20-pin	
50-pin	
Note	

17.5		
Type	Qty.	Order No.
ZQV 1.5N/2	60	1985410000
ZQV 1.5N/3	60	1985480000
ZQV 1.5N/4	60	1985490000
ZQV 1.5N/5	20	1985500000
ZQV 1.5N/6	20	1985510000
ZQV 1.5N/7	20	1985520000
ZQV 1.5N/8	20	1985540000
ZQV 1.5N/9	20	1985560000
ZQV 1.5N/10	20	1985580000
ZQV 1.5N/20	20	1985600000
ZQV 1.5N/50	5	1985620000

ZQV 2.5N



24		
Type	Qty.	Order No.
ZQV 2.5N/2	60	1527540000
ZQV 2.5N/3	60	1527570000
ZQV 2.5N/4	60	1527590000
ZQV 2.5N/5	20	1527620000
ZQV 2.5N/6	20	1527630000
ZQV 2.5N/7	20	1527640000
ZQV 2.5N/8	20	1527670000
ZQV 2.5N/9	20	1527680000
ZQV 2.5N/10	20	1527690000
ZQV 2.5N/20	20	1527720000
ZQV 2.5N/50	5	1527730000

ZQV 4N



32		
Type	Qty.	Order No.
ZQV 4N/2	60	1527930000
ZQV 4N/3	60	1527940000
ZQV 4N/4	60	1527970000
ZQV 4N/5	60	1527980000
ZQV 4N/6	20	1527990000
ZQV 4N/7	20	1528020000
ZQV 4N/8	20	1528030000
ZQV 4N/9	20	1528070000
ZQV 4N/10	20	1528090000
ZQV 4N/50	5	1528130000



Technical data	
current	A
Ordering data	
2-pin	
3-pin	
4-pin	
5-pin	
6-pin	
7-pin	
8-pin	
9-pin	
10-pin	
20-pin	
50-pin	
Note	

17.5		
Type	Qty.	Order No.
ZQV 1.5N/2 BL	60	1985530000
ZQV 1.5N/3 BL	60	1985550000
ZQV 1.5N/4 BL	60	1985570000
ZQV 1.5N/5 BL	20	1985590000
ZQV 1.5N/6 BL	20	1985610000
ZQV 1.5N/7 BL	20	1985630000
ZQV 1.5N/8 BL	20	1985640000
ZQV 1.5N/9 BL	20	1985660000
ZQV 1.5N/10 BL	20	1985680000
ZQV 1.5N/20 BL	20	1985700000
ZQV 1.5N/50 BL	5	1985720000



24		
Type	Qty.	Order No.
ZQV 2.5N/2 BL	60	1527740000
ZQV 2.5N/3 BL	60	1527770000
ZQV 2.5N/4 BL	60	1527780000
ZQV 2.5N/5 BL	20	1527790000
ZQV 2.5N/6 BL	20	1527820000
ZQV 2.5N/7 BL	20	1527830000
ZQV 2.5N/8 BL	20	1527840000
ZQV 2.5N/9 BL	20	1527870000
ZQV 2.5N/10 BL	20	1527880000
ZQV 2.5N/20 BL	20	1527890000
ZQV 2.5N/50 BL	5	1527920000



32		
Type	Qty.	Order No.
ZQV 4N/2 BL	60	1528040000
ZQV 4N/3 BL	60	1528080000
ZQV 4N/4 BL	60	1528120000
ZQV 4N/5 BL	60	1528140000
ZQV 4N/6 BL	20	1528170000
ZQV 4N/7 BL	20	1528180000
ZQV 4N/8 BL	20	1528190000
ZQV 4N/9 BL	20	1528220000
ZQV 4N/10 BL	20	1528230000
ZQV 4N/50 BL	5	1528240000



Technical data	
current	A
Ordering data	
2-pin	
3-pin	
4-pin	
5-pin	
6-pin	
7-pin	
8-pin	
9-pin	
10-pin	
20-pin	
50-pin	
Note	

17.5		
Type	Qty.	Order No.
ZQV 1.5N/2 RD	60	1985650000
ZQV 1.5N/3 RD	60	1985670000
ZQV 1.5N/4 RD	60	1985690000
ZQV 1.5N/5 RD	20	1985710000
ZQV 1.5N/6 RD	20	1985730000
ZQV 1.5N/7 RD	20	1985750000
ZQV 1.5N/8 RD	20	1985770000
ZQV 1.5N/9 RD	20	1985790000
ZQV 1.5N/10 RD	20	1985800000
ZQV 1.5N/20 RD	20	1985810000
ZQV 1.5N/50 RD	5	1985820000



24		
Type	Qty.	Order No.
ZQV 2.5N/2 RD	60	2108470000
ZQV 2.5N/3 RD	60	2108690000
ZQV 2.5N/4 RD	60	2108700000
ZQV 2.5N/5 RD	20	2108710000
ZQV 2.5N/6 RD	20	2108720000
ZQV 2.5N/7 RD	20	2108810000
ZQV 2.5N/8 RD	20	2108870000
ZQV 2.5N/9 RD	20	2108900000
ZQV 2.5N/10 RD	20	2108910000
ZQV 2.5N/20 RD	20	2108920000
ZQV 2.5N/50 RD	5	2109000000



32		
Type	Qty.	Order No.
ZQV 4N/2 RD	60	2460450000
ZQV 4N/3 RD	60	2460810000
ZQV 4N/4 RD	60	2460800000
ZQV 4N/5 RD	60	2460790000
ZQV 4N/6 RD	20	2460780000
ZQV 4N/7 RD	20	2460770000
ZQV 4N/8 RD	20	2460760000
ZQV 4N/9 RD	20	2460750000
ZQV 4N/10 RD	20	2460740000
ZQV 4N/50 RD	20	2460730000

ZQV 6N



41		
Type	Qty.	Order No.
ZQV 6N/2	60	1985740000
ZQV 6N/3	60	1985760000
ZQV 6N/4	60	1985780000

ZQV 10N/2



57		
Type	Qty.	Order No.
ZQV 10N/2	25	2497250000

ZQV 16N/2



76		
Type	Qty.	Order No.
ZQV 16N/2	25	2497290000

ZQV 35N/2



125		
Type	Qty.	Order No.
ZQV 35N/2	10	2634950000

Reducing insert		
Type	Qty.	Order No.
ZQV 35N - 16	10	2562660000
ZQV 35N - 10	10	2562670000



41		
Type	Qty.	Order No.
ZQV 6N/2 BL	60	1985830000
ZQV 6N/3 BL	60	1985840000
ZQV 6N/4 BL	60	1985850000



Test adapters for self-assembly:

The test adapters offer a flexible solution for every task - they can be connected by threading them together in accordance with the application to be fulfilled.

Note:

The start plate can only be combined with one size of expansion plate.



Structure of the test adapter system

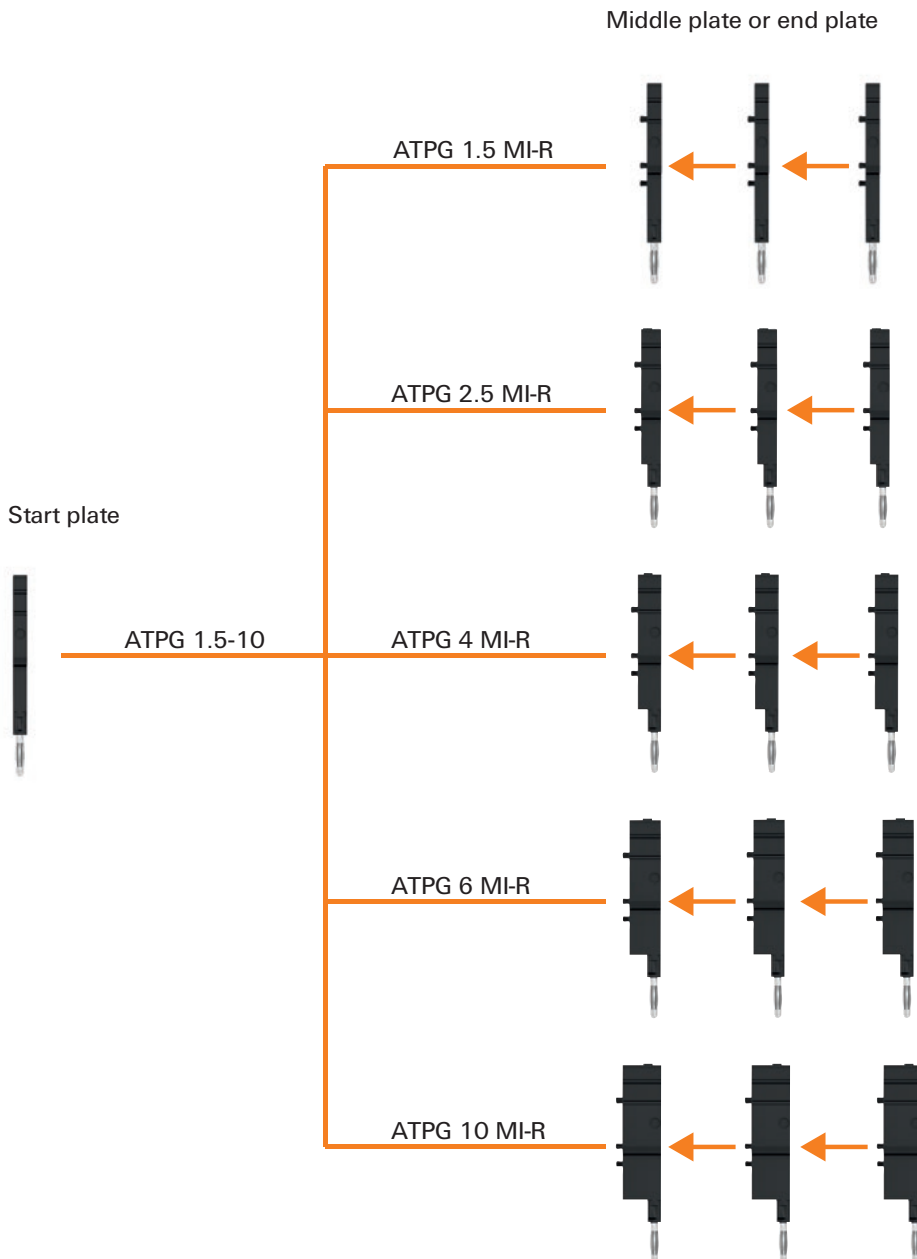



Testadapter

Der Testadapter ATPG wird als Einzelscheibe sowie als Testadapterleiste für Messungen eingesetzt. Durch einfaches Verrasten des Testadapters in der Reihenklammer wird die potenzialführende Stromschiene sicher kontaktiert.

Maße	
Breite / Länge / Höhe	mm
Abisolierlänge	-
Bemessungsdaten	
Bemessungsspannung	V
Nennstrom	A
bei Leiterquerschnitt	mm ²
Klemmbare Leiter (H05V/H07V)	
eindrätig / mehrdrätig	mm ²
feindrätig / feindrätig mit AEH	mm ²
Bestelldaten	
	1-polig
	3-polig
	5-polig
Hinweis	

ATPG 1.5-10

Startscheibe



3,5 / 18,5		
0,2		
1,5		
0,5...1,5		
0,5...1,5 / 0,5...1		
Typ	VPE	Best.-Nr.
ATPG 1.5-10 L	50	1991890000
Die Höhe ist abhängig vom Klemmentyp		

ATPG 1.5 MI-R

Mittelscheibe bzw. Endscheibe



3,5 / 18,5		
0,2		
1,5		
0,5...1,5		
0,5...1,5 / 0,5...1		
Typ	VPE	Best.-Nr.
ATPG 1.5 MI-R	50	1991880000
Die Höhe ist abhängig vom Klemmentyp		

ATPG 2.5 MI-R

Mittelscheibe bzw. Endscheibe



5,1 / 18,5		
0,2		
1,5		
0,5...1,5		
0,5...1,5 / 0,5...1		
Typ	VPE	Best.-Nr.
ATPG 2.5 MI-R	50	1991960000
ATPG 2.5/3	25	2041190000
ATPG 2.5/5	25	2041180000
Die Höhe ist abhängig vom Klemmentyp		

Testadapter

Der Testadapter ATPG wird als Einzelscheibe sowie als Testadapterleiste für Messungen eingesetzt. Durch einfaches Verrasten des Testadapters in der Reihenklammer wird die potenzialführende Stromschiene sicher kontaktiert.

Maße	
Breite / Länge / Höhe	mm
Abisolierlänge	-
Bemessungsdaten	
Bemessungsspannung	V
Nennstrom	A
bei Leiterquerschnitt	mm ²
Klemmbare Leiter (H05V/H07V)	
eindrätig / mehrdrätig	mm ²
feindrätig / feindrätig mit AEH	mm ²
Bestelldaten	
	1-polig
	3-polig
	5-polig
Hinweis	

ATPG 4 MI-R-10

Mittelscheibe bzw. Endscheibe



6,1 / 18,5		
0,2		
1,5		
0,5...1,5		
0,5...1,5 / 0,5...1		
Typ	VPE	Best.-Nr.
ATPG 4 MI-R	50	1991860000
Die Höhe ist abhängig vom Klemmentyp		

ATPG 6 MI-R

Mittelscheibe bzw. Endscheibe



7,9 / 18,5		
0,2		
1,5		
0,5...1,5		
0,5...1,5 / 0,5...1		
Typ	VPE	Best.-Nr.
ATPG 6 MI-R	50	1991930000
Die Höhe ist abhängig vom Klemmentyp		

ATPG 10 MI-R

Mittelscheibe bzw. Endscheibe



9,9 / 18,5		
0,2		
1,5		
0,5...1,5		
0,5...1,5 / 0,5...1		
Typ	VPE	Best.-Nr.
ATPG 10 MI-R	50	1991870000
Die Höhe ist abhängig vom Klemmentyp		



Reliable marking of live terminal blocks

Klippon® Connect warning labels for the A-series

The switchgear design must guarantee reliable protection of people against electric shock caused by dangerous touch voltages. Terminal blocks need special marking to warn when terminal blocks may have a voltage, even when the main switch is off.

Our new AAM warning labels enable eye-catching marking. They can be quickly and easily snapped onto terminal blocks of the A series in the cross-section range from 1.5 mm² to 16 mm². High-quality printing guarantees permanent marking even under adverse environmental conditions.

Your special advantages

- Highly visible marking of live terminal blocks
- Fast, tool-free assembly
- Resistant printing





AAM 1.5 YE FLASH



Dimensions	
Width / Height / Depth	mm
Continuous operating temp., min.	-40 °C
Continuous operating temp., max.	100 °C
Material	polyamide
UL 94 flammability rating	V-2
Ordering data	
	yellow
Note	

2,5 / 52,67 / 36,15		
-40 °C		
100 °C		
polyamide		
V-2		
Type	Qty.	Order No.
AAM 1.5 YE FLASH	40	2635520000

AAM 2.5 YE FLASH



2,5 / 75,51 / 45,15		
-40 °C		
100 °C		
polyamide		
V-2		
Type	Qty.	Order No.
AAM 2.5 YE FLASH	40	2635550000

AAM 4 YE FLASH



Dimensions	
Width / Height / Depth	mm
Continuous operating temp., min.	-40 °C
Continuous operating temp., max.	100 °C
Material	polyamide
UL 94 flammability rating	V-2
Ordering data	
	yellow
Note	

2,5 / 52,67 / 36,15		
-40 °C		
100 °C		
polyamide		
V-2		
Type	Qty.	Order No.
AAM 4 YE FLASH	40	2635560000

AAM 6 YE FLASH



2,5 / 75,51 / 45,15		
-40 °C		
100 °C		
polyamide		
V-2		
Type	Qty.	Order No.
AAM 6 YE FLASH	40	2635570000

AAM 10 YE FLASH



Dimensions	
Width / Height / Depth	mm
Continuous operating temp., min.	-40 °C
Continuous operating temp., max.	100 °C
Material	polyamide
UL 94 flammability rating	V-2
Ordering data	
	yellow
Note	

2,5 / 52,67 / 36,15		
-40 °C		
100 °C		
polyamide		
V-2		
Type	Qty.	Order No.
AAM 10 YE FLASH	40	2635580000

AAM 16 YE FLASH



2,5 / 75,51 / 45,15		
-40 °C		
100 °C		
polyamide		
V-2		
Type	Qty.	Order No.
AAM 16 YE FLASH	40	2635590000



Fast assembly and reliable fixation

Klippon® Connect end brackets for rail mounted components

The complexity in modern switchgear is growing, and the number of components inside the cabinet is constantly expanding. This components have to be fixed for the transport as well as for the whole lifetime.

The screwless Klippon® Connect end brackets of our A-series offer a solution. Our endbrackets have optimal designed marking areas and are available with or without preassembled marking areas (DL-version). Because of the gripper-optimized shape the bracket is also "ready to robot" like the terminals of A-series.

Your special advantages

- Various marking options
- Installation without any tools
- Available with preassembled marking areas

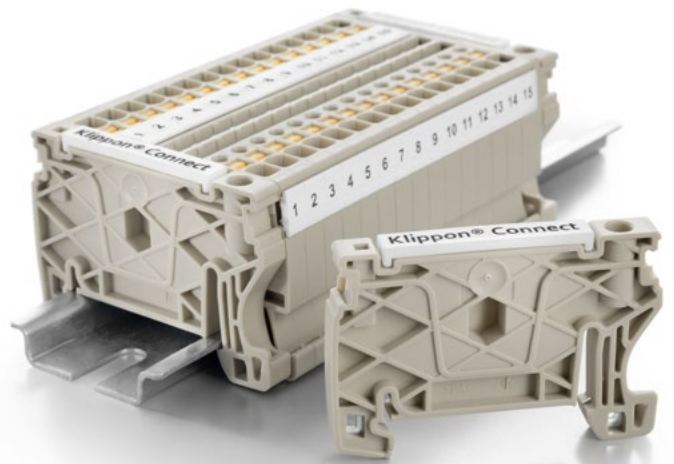

Ordering data

Type	Qty.	Order No.
AEB 35 SCL/1 V0	50	2661280000
AEB 35 SCL/1 V0 GY	50	2661290000
AEB 35 SCL/1 V0 BK	50	2661300000
AEB 35 SCL/1 V0 DL	50	2570240000
AEB 35 SCL/1 V0 BK DL	50	2570250000
AEB 35 SCL/1 V0 GY DL	50	2570260000

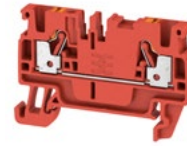
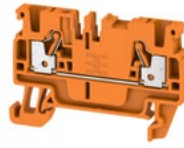
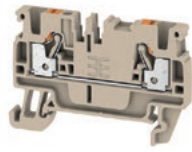

Type	Order No. beige	Order No. blue BL	Order No. orange OR	Order No. red RD
1.5 mm ²	A2C	1552790000	1552820000	2508020000
	A3C	1552740000	1552770000	2534500000
	A4C	1552690000	1552700000	2534430000
2.5 mm ²	A2C	1521850000	1521880000	1521900000
	A3C	1521740000	1521780000	1521800000
	A4C	1521690000	1521700000	1521710000
4 mm ²	A2C	2051180000	2051210000	2051220000
	A3C	2051240000	2051280000	2051300000
	A4C	2051500000	2051520000	2051530000
6 mm ²	A2C	1992110000	1991790000	-
	A3C	1991820000	1991830000	1991840000

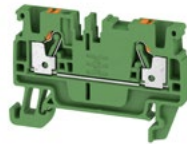
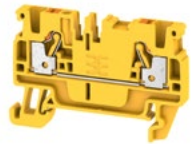

Type	Order No. yellow YL	Order No. green GN	Order No. white WT	Order No. black BK
1.5 mm ²	A2C	2508190000	2508210000	2508170000
	A3C	2534520000	2534480000	2534230000
	A4C	2534450000	2534410000	2534260000
2.5 mm ²	A2C	1521940000	1521950000	1521980000
	A3C	1521840000	1521870000	1521920000
	A4C	1521730000	1521770000	1521820000
4 mm ²	A2C	2051250000	2051260000	2051310000
	A3C	2051340000	2051350000	2051400000
	A4C	2051550000	2051580000	2051660000
6 mm ²	A2C	-	-	-
	A3C	-	-	-



Type	Order No. light grey LTGY	Order No. dark blue DBL	Order No. brown BR
1.5 mm ²	A2C	2508220000	2508180000
	A3C	2534490000	2534540000
	A4C	2534420000	2534470000
2.5 mm ²	A2C	2003110000	2508000000
	A3C	2003120000	2534690000
	A4C	2003130000	2534740000
4 mm ²	A2C	2051330000	2534370000
	A3C	2051460000	2534290000
	A4C	2051670000	2534390000
6 mm ²	A2C	-	-
	A3C	-	-